

Liebert iCOM™

User Manual - Intelligent Communications & Monitoring



TABLE OF CONTENTS

1.0	INTRODUCTION	1
1.1	Features	1
2.0	LIEBERT ICOM DISPLAY COMPONENTS AND FUNCTIONS	2
2.1	Navigating Through the Liebert iCOM Menus	5
2.1.1	Control Interface	5
2.1.2	Accessing Submenus	5
2.1.3	Entering a Password	6
2.1.4	Viewing Multiple Units with a Networked Large Display	8
3.0	OPERATION	12
3.1	Single Unit Functions	12
3.1.1	Unit/Fan Control	12
3.1.2	Chilled Water Units with Variable Speed Motor	13
3.1.3	General Compressor Requirements	14
3.1.4	Compressor Timing—Units With Two Compressors	15
3.1.5	Compressor Sequencing	15
3.2	Temperature Control—Single Source Cooling (No Extra Cooling Coil)	16
3.2.1	Temperature Proportional Band	16
3.2.2	Compressor Control	17
3.2.3	Chilled Water Control	20
3.3	Temperature Control—Second Cooling Source	20
3.3.1	Differential Temperatures / Controls (Comparator Circuit)	20
3.4	Temperature Control—Reheat	22
3.4.1	Three-Stage Electric, Hot Gas and Hot Water Reheat	22
3.4.2	SCR Reheat	24
3.5	Humidity Control	26
3.5.1	Humidification	27
3.5.2	Dehumidification	28
3.6	Control Types	29
3.6.1	Temperature and Humidity Control Types	29
3.6.2	Humidity Sensor Reading Control Types	30
3.6.3	Supply Limit—Optional	31
3.6.4	High and Low, Temperature and Humidity Events	31
3.6.5	User Inputs / Customer Inputs	32
3.6.6	Event Types and Properties	33
3.7	Possible Event Notifications	35
3.8	Next Maintenance Calculation	36
3.8.1	Calculation of Next Maintenance and Diagnostics	36

4.0	TEAMWORK	38
4.1	Teamwork Modes	38
4.1.1	Application of Teamwork Modes	38
4.1.2	No Teamwork	38
4.1.3	Teamwork Mode 1	38
4.1.4	Teamwork Mode 2	40
4.1.5	Standby – Rotation.....	40
5.0	INSTALLING A LIEBERT ICOM UNIT-TO-UNIT NETWORK	41
5.1	Placement of Cooling Units	41
5.2	U2U Hardware: Cables and Network Switch.....	41
5.3	Wiring for Unit-to-Unit Communications—U2U	42
5.3.1	Wiring a Liebert iCOM U2U Network	43
5.4	External Communications—Building Management Systems, Liebert SiteScan®	47
6.0	MOUNTING A LARGE DISPLAY ON A WALL	48
6.0.1	Location Considerations.....	48
7.0	USER MENU PARAMETERS	50
8.0	SERVICE MENU PARAMETERS	55

FIGURES

Figure 1	Liebert iCOM components	1
Figure 2	Liebert iCOM display components	2
Figure 3	Status menu, large display, graphical view	4
Figure 4	Liebert iCOM default screen symbols	4
Figure 5	Menu tree—Small display, stand-alone or networked	6
Figure 6	Menu tree—Large display, stand-alone	7
Figure 7	Menu tree—Large display, networked	8
Figure 8	User menu icons	9
Figure 9	Service menu icons	11
Figure 10	Start-stop priority switches	12
Figure 11	Temperature proportional band	16
Figure 12	One single-step compressor without unloaders	17
Figure 13	Two single-step compressors without unloaders or one compressor with an unloader (two-step)	17
Figure 14	Two compressors with unloaders (four-step)	18
Figure 15	Digital scroll capacity modulation, 10-100% variable	19
Figure 16	Single and dual digital scroll compressor activation points	19
Figure 17	Three-point actuator control (example: cooling)	20
Figure 18	Second cooling source and compressorized cooling	21
Figure 19	Three-stage heating	23
Figure 20	Two single-step compressors with SCR reheat set to Tight mode	24
Figure 21	Two single-step compressors with SCR reheat set to Standard mode	25
Figure 22	Humidity proportional band	26
Figure 23	Teamwork Mode 1 with two cooling units	39
Figure 24	Connecting two cooling units, each with a small display using a crossover Ethernet cable	43
Figure 25	Wiring a small display for stand-alone operation	44
Figure 26	Wiring a small display for U2U network operation	44
Figure 27	Wiring a large display for stand-alone operation	45
Figure 28	Wiring a large display for U2U network operation	45
Figure 29	Liebert iCOM input-output control board	46
Figure 30	Liebert vNSA with optional remote large display	47
Figure 31	Liebert iCOM display dimensions	49

TABLES

Table 1	Keyboard icons and functions	3
Table 2	User menu icons	9
Table 3	Service menu icons	11
Table 4	Reheat configuration types	22
Table 5	Parameters for infrared humidifier control	27
Table 6	Dehumidification With Comp settings	28
Table 7	Customer inputs	32
Table 8	Possible event settings—some events not available in all units	34
Table 9	Event notifications—large or small display	35
Table 10	Sample Liebert iCOM network configurations	42
Table 11	Ports available for connecting Liebert iCOM control devices	46
Table 12	Setpoints parameters	50
Table 13	Spare part list parameters—large display only	50
Table 14	Event log parameters	50
Table 15	Graphics parameters	51
Table 16	View network parameters—large display only*	51
Table 17	Set alarms parameters	51
Table 18	Sensor data parameters	52
Table 19	Active alarms parameters	52
Table 20	Display setup parameters	53
Table 21	Total run hours parameters	53
Table 22	Timer parameters—Sleep Mode	54
Table 23	Service contacts parameters	54
Table 24	Setpoints parameters	55
Table 25	Unit diary parameters	56
Table 26	Maintenance / wellness settings parameters	57
Table 27	Standby settings / lead-lag parameters	57
Table 28	Diagnostics / service mode parameters	60
Table 29	Set alarms parameters	62
Table 30	Set alarms parameters (continued)	64
Table 31	Sensor calibration / setup parameters	66
Table 32	System / network setup parameters—large display only	67
Table 33	Network setup parameters	68
Table 34	Options setup parameters	69
Table 35	Service contacts parameters	70

1.0 INTRODUCTION

The Liebert iCOM™ control offers the highest capabilities in unit control, communication and monitoring of Liebert mission-critical cooling units.

Liebert iCOM may be used to combine multiple cooling units into a team that operates as a single entity, enhancing the already-high performance and efficiency of Liebert's units.

Liebert iCOM is available as a factory-installed assembly or may be retrofitted on existing products with SM, AM or AG controls. Large graphic display wall-mount versions of the control are available for remote operation and monitoring of cooling units.

1.1 Features

Large and Small Displays

The Liebert iCOM control is available with either a large or small liquid crystal display.

- The **Liebert iCOM with small display** has a 128 x 64 dot matrix screen that simultaneously shows two menu icons, along with descriptive text. This display is capable of controlling only the unit it is directly connected to.
- The **Liebert iCOM with large display** has a 320 x 240 dot matrix screen that shows up to 16 menu icons at a time, as well as descriptive text. This display can be used to control a single cooling unit or any cooling unit on a network, regardless of how it is connected—either integrated into a cooling unit or simply connected to the network and mounted remotely.

Liebert iCOM's menu-driven display is used for all programming functions on each connected cooling unit. The Status menu shows the status of the conditioned space, such as room temperature and humidity, temperature and humidity setpoints, alarm status and settings, event histories and the current time.

Figure 1 Liebert iCOM components



Wall Mount Large Display



Direct Panel Mount Large Display and Bezel



Direct Panel Mount
Small Display and Bezel

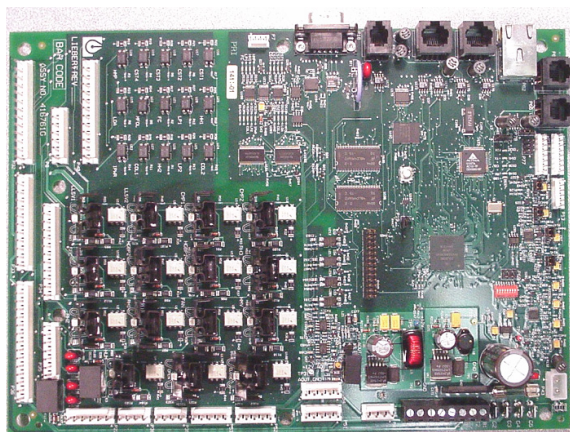

Liebert iCOM Input/Output Board

2.0 LIEBERT iCOM DISPLAY COMPONENTS AND FUNCTIONS

The small and the large display have a common key layout, as shown in **Figure 2**.

Figure 2 Liebert iCOM display components

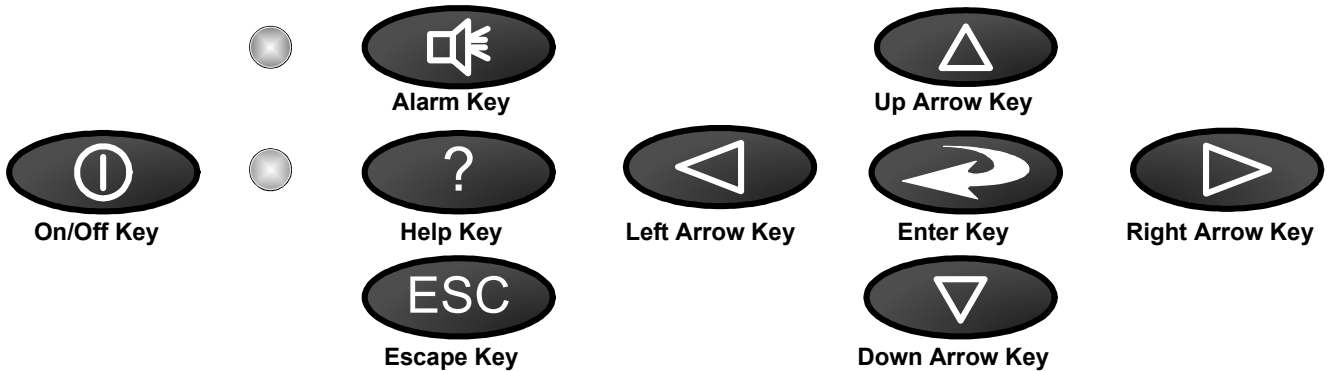
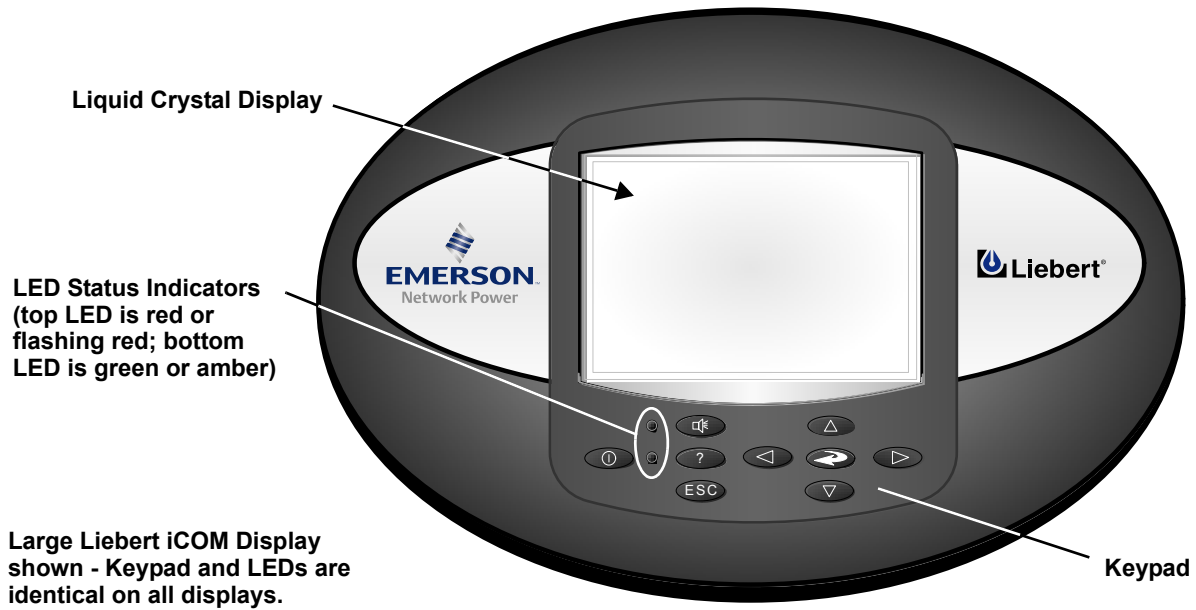

NOTE

The Help key may be pressed at any time for a brief explanation of what is being viewed.

Table 1 Keyboard icons and functions











Icon	Key Name	Function
	On/Off Key	Controls the operational state of the cooling unit.
	Alarm Key	Silences an alarm.
	Help Key	Accesses integrated help menus.
	ESCape Key	Returns to the previous display view.
	Enter Key	Confirms all selections and selects icons or text.
	Increase Key (Up Arrow)	Moves upward in a menu or increases the value of a selected parameter.
	Decrease Key (Down Arrow)	Moves downward in a menu or reduces the value of a selected parameter.
	Left and Right Arrow Keys	Navigates through text and sections of the display.
	Upper LED	Blinking Red—Active, unacknowledged alarm exists
		Solid Red—Active, acknowledged alarm exists
	Lower LED	Amber—Power is available to the unit, unit is NOT operating
		Green—Power is available to the unit, unit is operating

Figure 3 Status menu, large display, graphical view

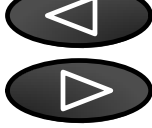
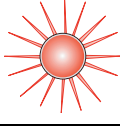
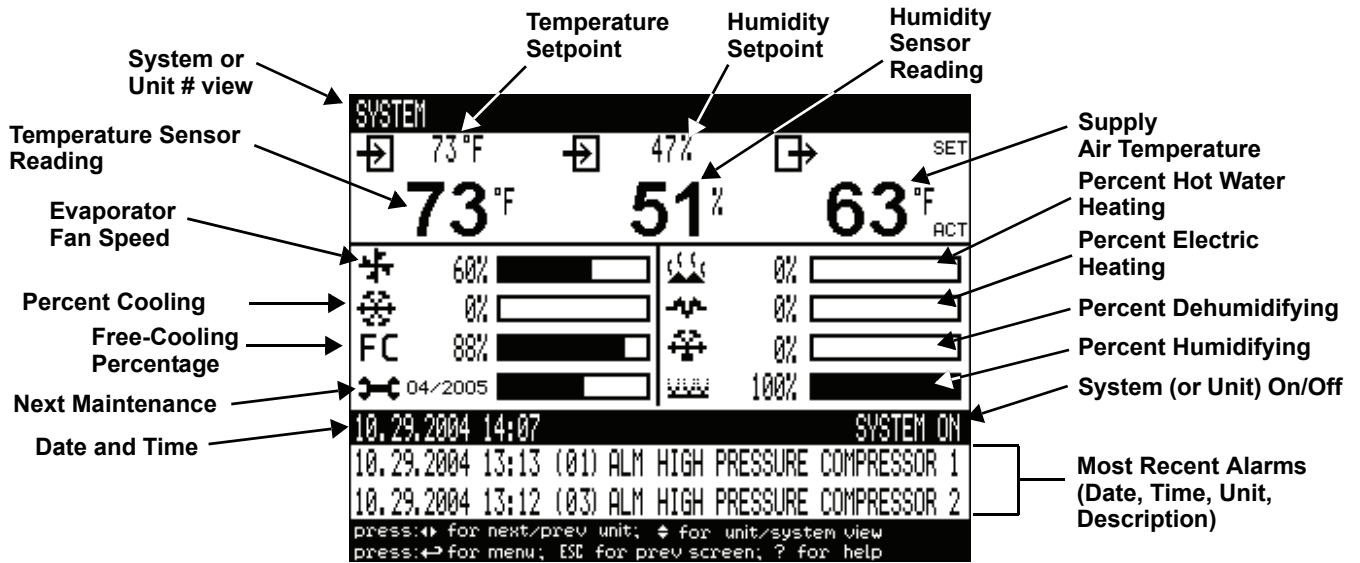
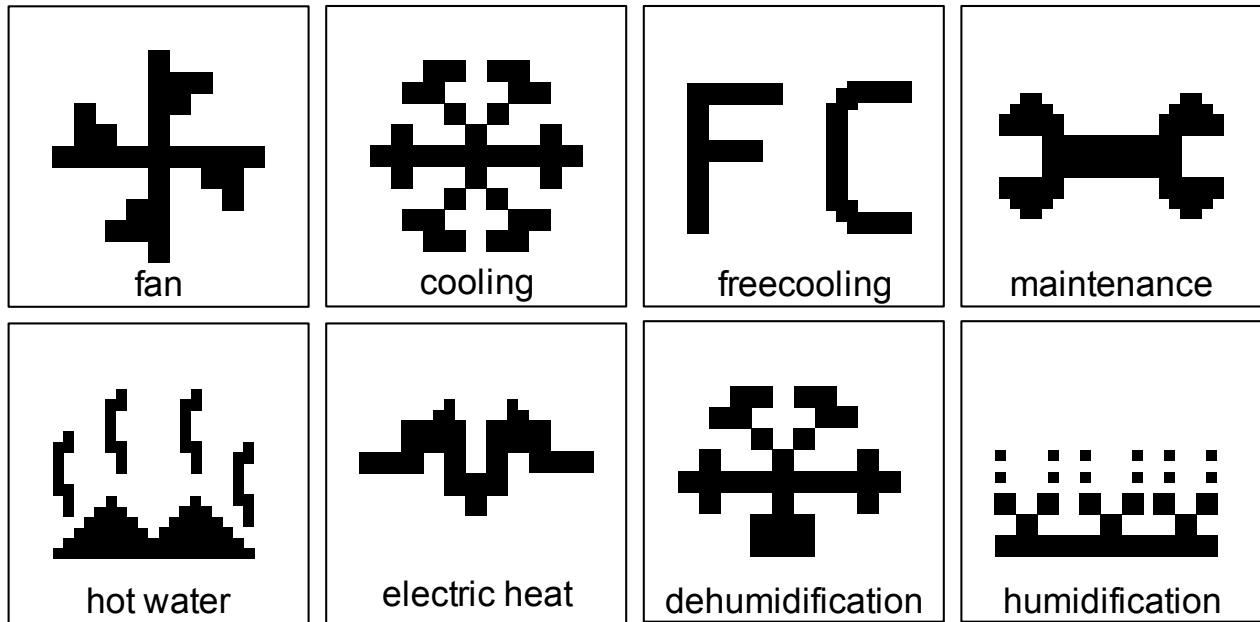

Figure 4 Liebert iCOM default screen symbols



2.1 Navigating Through the Liebert iCOM Menus

Liebert iCOM shows icons and text for monitoring and controlling your Liebert cooling units or network of cooling units. The number of icons and amount of text shown depends on the display size.

2.1.1 Control Interface

When the buttons on the Liebert iCOM control have not been pressed for a short period, the display backlight turns off. Pressing any key will turn the backlight on (wake up the screen) and display the Status menu of the last cooling unit viewed. The Status menu will show the cooling unit's operational mode(s), return air temperature and humidity readings, temperature and humidity setpoints and any active alarm conditions.

If the cooling unit has a large display and is not on a network, or if the unit has a small display, whether it is networked or stand-alone, the Status menu will display only that cooling unit's information. Any large display that is connected to a network can be used to view any cooling unit on the network or show an average view of the entire system of cooling units.

The Liebert iCOM control has three main menus; User, Service and Advanced.

The User menu contains the most frequently used features, settings and status information. The Service menu contains settings and features used to set up unit communications and for unit maintenance. The Advanced menu contains settings used to set up the unit at the factory.



NOTE

*Menu settings may be viewed without a password, but changing settings requires a password. If a password is required, Liebert iCOM shows a prompt to enter the password. The password for the User menu is 1490. The password for Service menu is 5010. For details on entering a password, see **Entering a Password on page 6***

2.1.2 Accessing Submenus

To access the User, Service or Advanced menu, press the Enter or down arrow key while viewing the Status menu of the unit you wish to access. The User menu will be displayed first. To view the Service or Advanced menus, press the right arrow key.

Accessing Submenus on Small Displays

While viewing the menu you wish to access (User, Service or Advanced), use the up and down arrow keys to scroll through the icons page-by-page. To scroll through the icons one-by-one, press the enter key and then use the up and down arrow keys. With the desired icon highlighted, press the enter key to enter that submenu. Once in a Submenu, a list of parameters is displayed.

Press the enter key and use the up and down arrow keys to scroll through the parameters one-by-one. Pressing the Esc key will go back a level. **Figure 5** shows the Liebert iCOM control menus for a small display.

Accessing Submenus on Large Displays

While viewing the menu you wish to access (User, Service or Advanced), press the enter key to highlight the first icon. Use the arrow keys to navigate through the icons. With the desired icon highlighted, press the enter key to enter that submenu. Once in a Submenu, a list of parameters will be displayed.

The up and down arrow keys may be used to scroll through the parameters page-by-page if the submenu has multiple pages. To scroll item-by-item, press the Enter key and then use the up and down arrow keys. Using the right or left arrow keys on large displays attached to a network will change the unit being viewed. Pressing the Esc key will go back a level. **Figures 6 and 7** show the Liebert iCOM control menus for a stand-alone large display and for a networked large display, respectively.



NOTE

Settings are readable without a password, but changing settings requires a password.

2.1.3 Entering a Password

To change the value of a parameter in a menu, you must first enter the password for that menu. The User, Service and Advanced menus each has a unique password to prevent unauthorized changes.

The User menu password is 1490; the Service menu password is 5010.



NOTE

Entering the Service menu password permits access to both the User and Service menus.

To enter a password:

1. Navigate to the menu that contains the parameter to be changed.
2. Select *Password* in the submenu by pressing the Enter key
3. Press the Enter key to move your cursor to the right side of the screen to select the question marks.
4. Use the arrow keys to enter the numeral for the password's first digit (the up arrow key moves from 1 to the next digit).
5. Use the right arrow key to move to the next question mark and repeat **Step 4** to enter all digits in the password.
6. After entering the password, press enter.

If the password is correct, the *Actual Level* shown to the right of *Password* will change from 0 to 1 or 2. The menu will remain locked if the password was incorrect.



NOTE

Returning to the Status menu will require re-entering a password to make changes.

Figure 5 Menu tree—Small display, stand-alone or networked

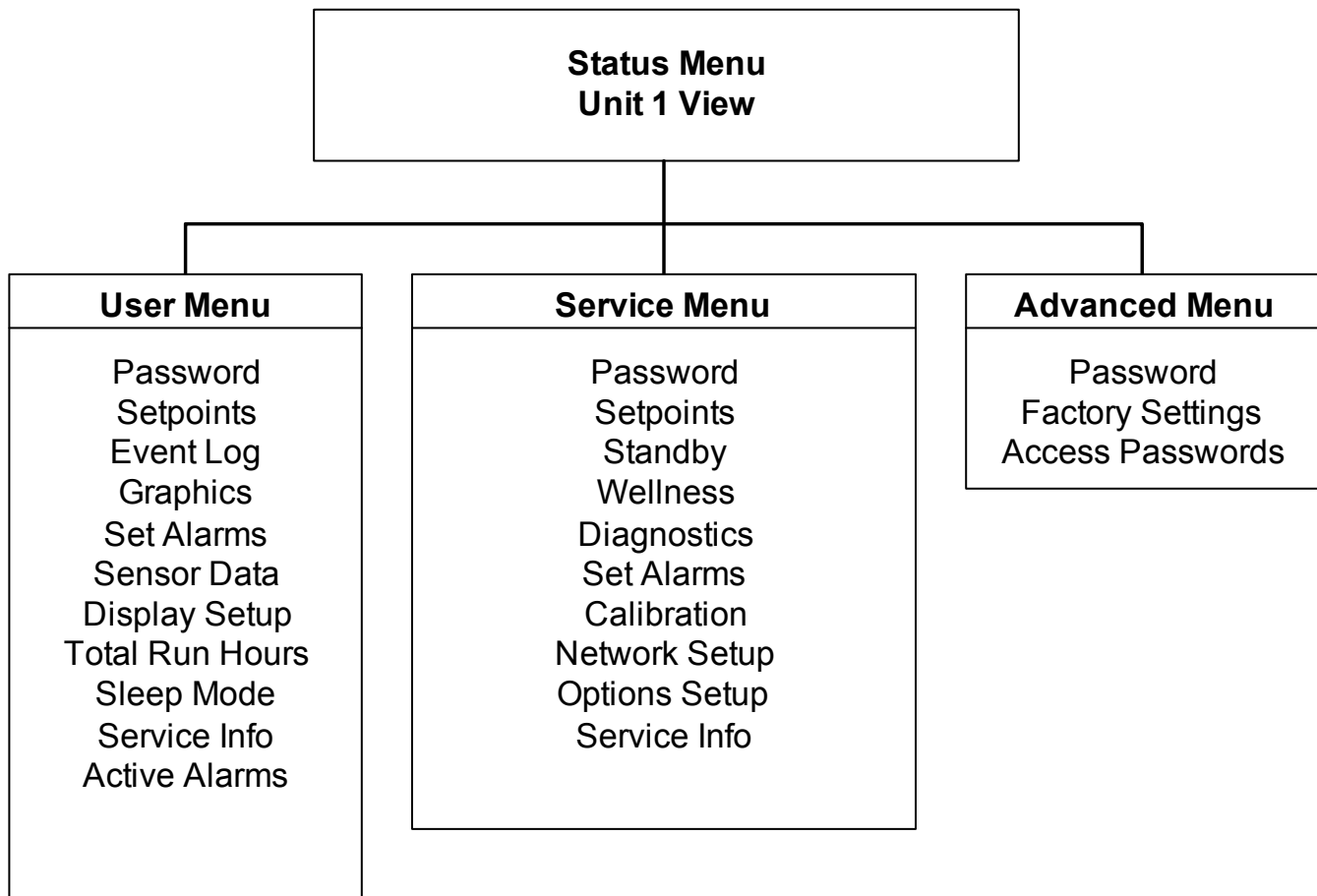
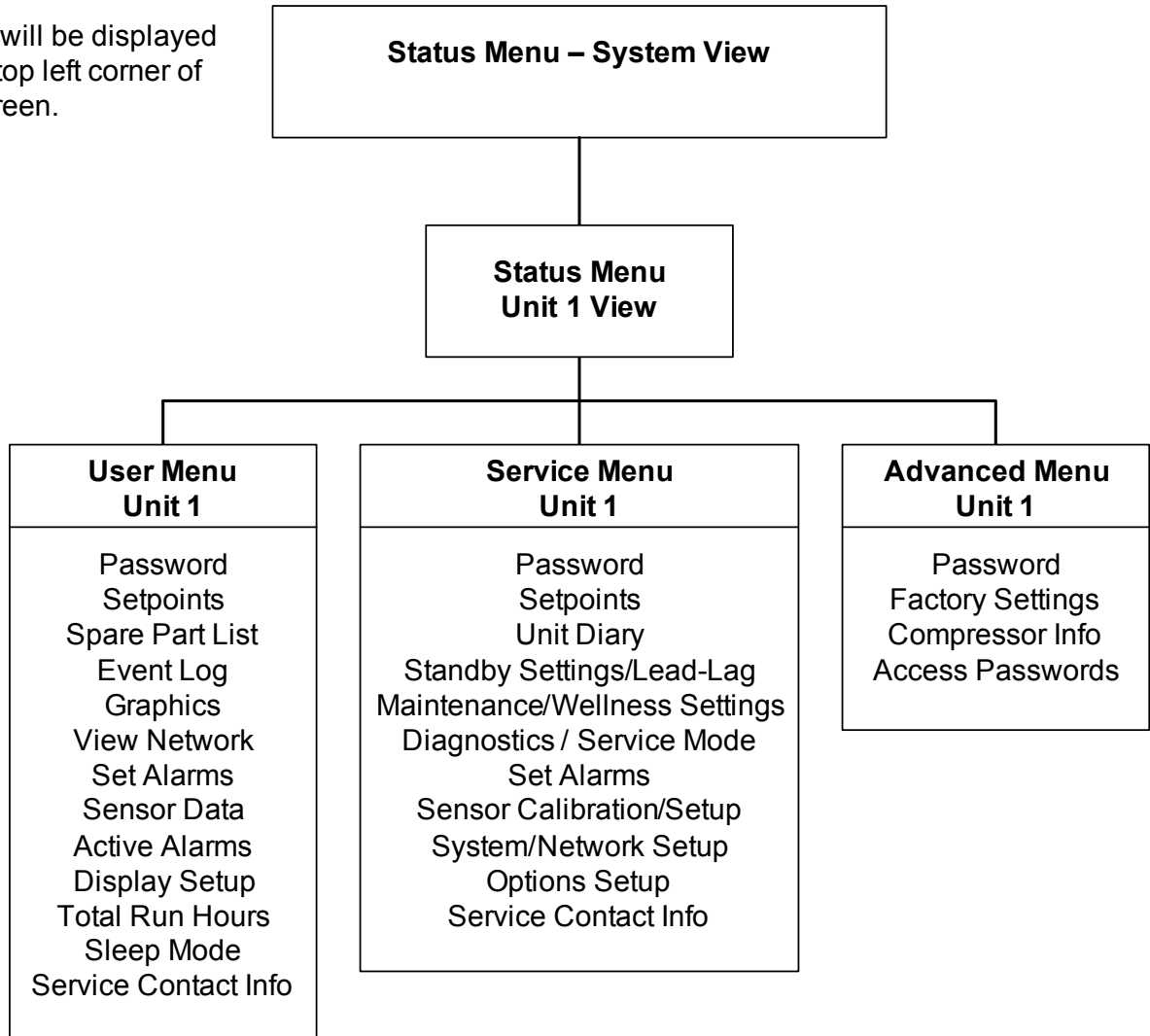

Figure 6 Menu tree—Large display, stand-alone

Unit 1 will be displayed in the top left corner of the screen.



2.1.4 Viewing Multiple Units with a Networked Large Display

When you first wake up the control, press the Esc key to return to the System view Status menu. This view shows an average of all the units on the network and any alarms present. To view a specific unit on the network, press either the enter key or down arrow key. When you do this, you will see the word *System* in the top left of the screen change to a unit number. Using the left and right arrow keys you can toggle through the various units on the network. To go back to the System view, or back one level from any menu in the control, press the Esc key.

Figure 7 Menu tree—Large display, networked

Unit# or *System* will be displayed in the top left corner of the screen .

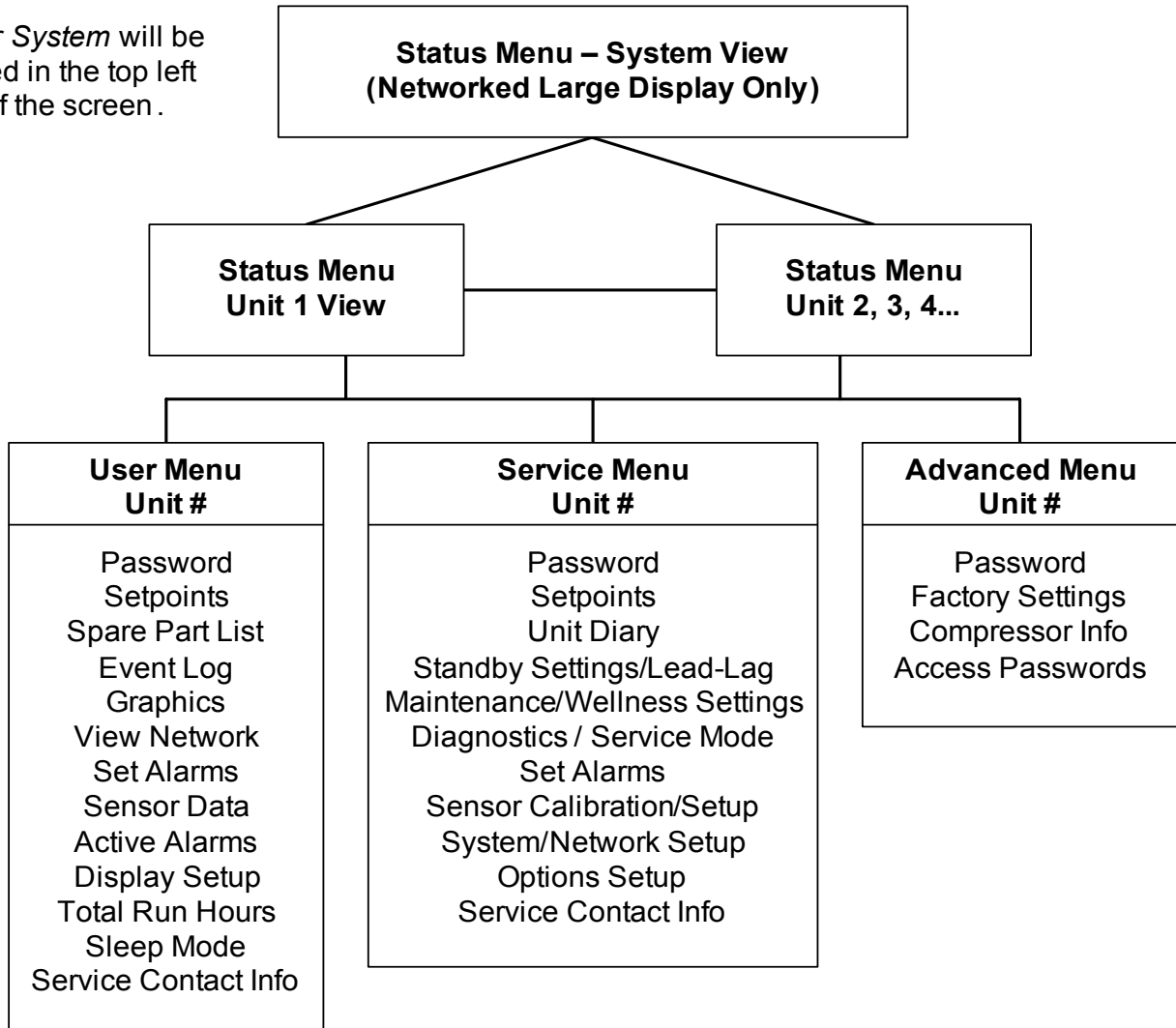
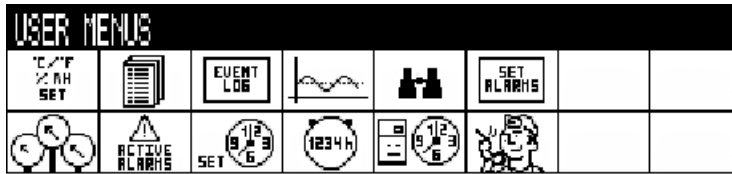

Figure 8 User menu icons



User Menu password: 1490

Table 2 User menu icons

Icon	Name	Description	Available On Display
	Setpoints	View and change temperature and humidity setpoints	Small & Large
	Spare Part List	Displays the various part numbers of the components/parts in the cooling unit	Large
	Event Log	Contains last 400 events	Small & Large
	Graphics	Displays temperature and humidity graphs	Small & Large
	View Network	Shows status of all connected units	Large
	Set Alarms	Allows enable, disable and settings for alarms	Small & Large
	Sensor Data	Shows readings of standard and optional sensors	Small & Large
	Active Alarms	Allows the user to view all current active alarms	Small & Large
	Display Setup	Change settings for display: language, time, simple or graphic view	Small & Large
	Total Run Hours	Records the run time of all components and allows setting of limits on run time	Small & Large

Table 2 User menu icons (continued)



Icon	Name	Description	Available On Display
	Sleep Mode	Allows setback settings for non-peak operation	Small & Large
	Service Contact Info	Contains key contact information for local service, including names and phone numbers	Small & Large

Figure 9 Service menu icons

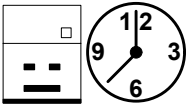

Service Menu password: 5010

Table 3 Service menu icons

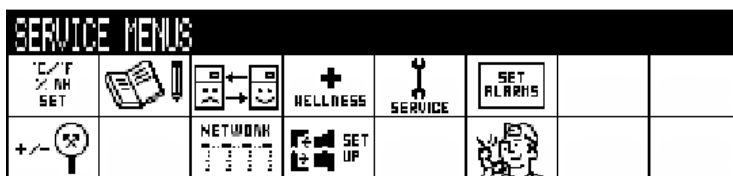
Icon	Name	Description	Available On Display
	Setpoints	To view and change temperature and humidity setpoints	Small & large
	Unit Diary	Shows all entered program changes and maintenance performed on the unit	Large
	Standby Settings/ Lead-Lag	Allows lead/lag setup when multiple units are connected	Small & large
	Maintenance/ Wellness Settings	Allows setting maintenance interval reminder, maintenance message, number of unit starts and stops, and time since last maintenance	Small & large
	Diagnostics/ Service Mode	Allows troubleshooting, manual mode, read analog and digital inputs	Small & large
	Set Alarms	Allows enable, disable and settings for alarms	Small & large
	Sensor Calibration/Setup	Allows calibration of sensors	Small & large
	System/Network Setup	Allows setup and U2U communication for multiple units	Large
	Options Setup	Allows setup of component operation	Small & large
	Service Contact Info	Contains key contact information for local service, including names and phone numbers	Small & large

3.0 OPERATION

The Liebert iCOM display for your Liebert cooling unit features an easy-to-use, menu-driven liquid crystal display (LCD). All unit settings and parameters can be viewed and adjusted through three menus: User, Service and Advanced. All active alarms are displayed on the LCD and annunciated.

The control is shipped from the factory with default selections for all necessary settings. Adjustments can be made if the defaults do not meet your requirements.

References to menu items in this manual are followed by the main menu and the submenu where they can be found.

For example:

- **Temperature Setpoint (User Menu, Setpoints)** - The Temperature Setpoint parameter is located in the User menu under the Setpoints submenu.
- **High Return Humidity (Service Menu, Set Alarms)** - The High Return Humidity alarm is located in the Service menu under the Set Alarms submenu.

3.1 Single Unit Functions

3.1.1 Unit/Fan Control

Start - Stop

Unit on means the fan output is activated. The unit can be switched On and Off from two inputs:

1. Remote on/off input
2. Display button

Pressing the On/Off key on a small display will control only the cooling unit it is connected to regardless, of whether the cooling unit is a stand-alone unit or part of a network.

Pressing the On/Off key on a large display of a stand-alone cooling unit will control only that unit.

The effect of pressing the On/Off key on a large display connected to a network depends on the view: System or Unit.

- In System view, pressing the On/Off key shows a warning asking for confirmation to **shut down the entire system**.
- In Unit view, pressing the On/Off key affects only the unit being viewed, without a confirmation request.

Each time a unit is powered on or off, an event is added to the Event Log in the User menu.



NOTE

Customer switches: remote On/Off (if used) and display On/Off switches are in series. A cooling unit will start only if both switches are On; if one of these switches is Off, the unit will stop. Safety devices within the unit are also in series and will shut the unit down if required.

Figure 10 Start-stop priority switches

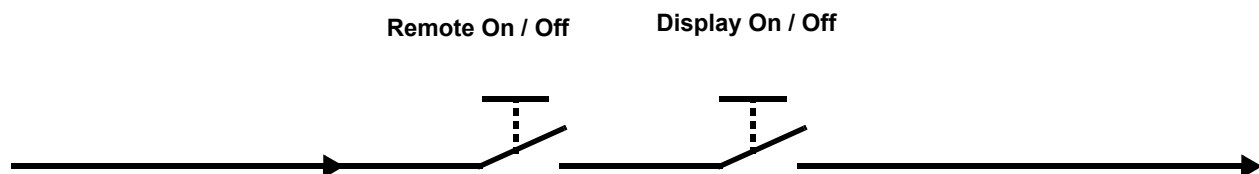

NOTE

If Remote On/Off is not used, a jumper is inserted to bypass the switch.

Autorestart

When there is a loss of power to the cooling unit and power comes back, the unit will return to its previous operating status—on if it was on before the power off, off if it was off.

When power returns, the autorestart time—time-selectable: Single Unit Auto Restart (Service Menu, Options Setup)—controls the start of the unit. The autorestart time runs in a loop, starting the next unit each time when elapsed, starting with Unit # 1.

Loss of Power Alarm

A Loss of Power Alarm is activated when power is restored after an interruption. If acknowledged, the alarm resets automatically after 30 minutes. This alarm can be set to different event types (Message, Alarm or Warning) and can be disabled under menu item Loss of Power (Service Menu, Set Alarms).



NOTE

Loss of power alarm will be activated only on units that had the fan on before power was lost.

Fan Alarm / Fan Protection Settings

The fan operation is protected by two digital devices: motor protection (optional) and a differential pressure switch. The motor protection monitors for main fan overload and the differential pressure switch ensures that the blower(s) are moving air. If either protection device triggers, an alarm will be announced by a buzzer, alarm relay and event to monitoring after an adjustable time-delay (Main Fan Overload and Loss Of Airflow in Service Menu, Set Alarms).

The time delay at the unit start is always five seconds shorter than the control delay (to avoid short component starting when the fan is not working). During operation, the fan delay is fixed to 15 seconds.

There are two selection possibilities for both, Loss Of Airflow and Main Fan Overload:

- **Shutdown**—stops the unit (intended for DX models).
- **Disable**—stops the humidifier, electrical heaters and dehumidification; allows cooling and free-cooling only (intended for chilled water models / external cooling).



NOTE

When the Main Fan Overload alarm is active, the Loss of Airflow alarm is masked out.

3.1.2 Chilled Water Units with Variable Speed Motor

VSD Fan Speed (Auto or Manual VSD Fan Speed Control)

The parameter VSD Fan Speed (Service Menu, Setpoints) allows the cooling unit's fan motor speed to be set for:

- **Auto operation:** when set to Auto, the speed of the VSD (variable speed drive) motor follows the position of the chilled water valve based on predetermined logic for cooling and dehumidification operation.
- **Manual operation:** when set to Manual, the speed of the VSD motor follows user input as set either locally at the cooling unit's Liebert iCOM display (under VSD Setpoint in Service Menu, Setpoints) or remotely using Modbus BMS signal with an optional Liebert IntelliSlot[®] 485 card.

VSD Setpoint (VSD Fan Speed Setting)

If the VSD Fan Speed Control (Service Menu, Setpoints) is set for Manual, the VSD Fan Speed Setpoint (Service Menu, Setpoints) may be set for the desired speed of the variable speed motor.

Depending on the product control design, there may be an internal minimum speed, as defined by that specific product operation, while the customer input may be set for 0-100%:

- Fan speed may be set locally at the unit using the Liebert iCOM display.
- Fan speed may be set remotely via a BMS signal (sent via Modbus using an optional Liebert IntelliSlot 485 card), which then transmits to the unit local control.

3.1.3 General Compressor Requirements

Low-Pressure Time Delay

When the compressor starts, the low-pressure input is ignored for a selected period of time based on the setting of the Low Pressure Alarm Delay (Service Menu, Options Setup). This time is usually set to 3 minutes on air-cooled units, and to 0 or 1 minute on water cooled units. When this time is expired, a second timer starts to operate if the low-pressure input is active. This second timer is active during normal compressor operation to avoid compressor trips due to bubbles in the refrigerant or other influences creating short trips of the low-pressure switch. The low-pressure switch input is enabled only if the compressor is operating. Exception: Pump Down (see **Pump Down**).



NOTE

Low-pressure condition could be read through contacts or through pressure transducers with threshold setting.

Pump Down

The Pump Down operation is performed to protect the compressor oil from being diluted with liquid refrigerant to ensure that the compressor is properly lubricated for the next startup. The Pump Down operation operates in the following manner:

Whenever a compressor is turned Off and the low-pressure switch is closed (pressure OK), the compressor will be operated with the LLSV (liquid line solenoid valve) closed (de-energized) until the low-pressure switch opens (low-pressure condition, without giving alarm). When there is a call to turn off a compressor the LLSV is closed. If the low suction pressure switch (LPS) does not open within a specified time, the LLSV is turned On then back Off (to try to unstick the LLSV). The control will then wait a set period of time for the LPS to open. This will happen three times. If, after three times, the low suction pressure switch does not open, the compressor and LLSV are locked off and an alarm “Pump Down not completed” will appear.

There is a re-pump down if the LPS opens again after the compressor has been already stopped—a maximum of six re-pump-down cycles per hour are allowed. At the seventh request of re-pump down the alarm “Comp 1 Pumpdown Fail” or “Comp 2 Pumpdown Fail” will appear and the compressor will be locked out.

Pump down is always performed loaded (for compressors with unloaders: unloaders off, digital scroll: control solenoid valve disabled).

For digital scroll only: when pump down has finished successfully (LPS opened), pump down will be continued for another half-second with the control solenoid valve energized.

High Pressure Alarm

When the compressor is initially activated, the system will be monitored for a high pressure situation. When a high pressure situation is detected during the first 10 minutes of operation, the unit will attempt to correct the problem several times without notification. If the unit is unsuccessful in correcting the problem, an alarm will occur and the affected compressor will be locked off. If high head pressure alarm trips three times in a rolling 12 hour period, the affected compressor will be locked off.

After the compressor has been running for 10 minutes, if a high head pressure situation is detected, an alarm will occur and the affected compressor will be immediately locked off without the unit trying to correct the problem.

Once the compressor is locked off, it will not come back on until main power is reset, or until the HP Alarm Counters (Service Menu, Diagnostics) are reset to 0. Setting the counter to 0 will auto-reset the alarm without the need of pressing the reset button on the display. Even if the pressure in the system drops below the alarm point, the compressor will remain off until the system is reset.



NOTE

If the unit is equipped with manual reset high head pressure switches, or if the auto reset high head pressure switches don't reset, the compressor will not be turned back on, but there will be a 30-second delay from when the high head pressure situation occurs and when the alarm is annunciated.

Digital Scroll High Temperature

A protective maximum operating compressor temperature limit is imposed on units with digital scroll compressor(s) with thermistor. Once the digital scroll temperature reaches the maximum temperature threshold, the compressor will be locked out for at least 30 minutes and an alarm will be annunciated. If after 30 minutes the temperature has cooled to a safe operating temperature, the compressor will resume operation.

Each time a high-temperature alarm occurs, HT 1 Alarm Counter (Service Menu, Diagnostics) or HT 2 Alarm Counter (Service Menu, Diagnostics) is increased by one. Once these counters reach five occurrences in a rolling four-hour period, the compressor will be locked out. The alarm can be reset once the temperature returns to a safe level by:

1. Setting the counter back to 0 from the display and pressing the alarm reset button.
2. Shutting off power to the control board by turning the cooling unit's main power disconnect switch Off and On.

3.1.4 Compressor Timing—Units With Two Compressors

To help maximize the life of your compressor(s), there is a start-to-next start delay for each single compressor.

A Minimum ON time and a Minimum Off time may be selected in the Advanced menu (minimum three minutes for single phase compressors). Consult the factory on how to modify the Minimum ON and OFF time settings.

3.1.5 Compressor Sequencing

Compressor Sequencing parameter (Service Menu, Options Setup) is intended to maintain equal run times between compressors. This setting has three selection possibilities:

- Always use Compressor 1 as lead compressor
- Always use Compressor 2 as lead compressor
- Auto:
 - First priority: if the safety timings are acceptable for only one compressor, then it is the next to be started/stopped.
 - If both compressors are off: the one with fewer working hours is the next to start.
 - If both compressors are in operation: the one that has been operating longer since the last start is the next to be stopped.



NOTE

The Auto setting attempts to maintain equal run times between compressors.

3.2 Temperature Control—Single Source Cooling (No Extra Cooling Coil)

3.2.1 Temperature Proportional Band

The control uses the temperature proportional band to determine which operation to perform (cooling/heating) and how intensely to perform it. The Temperature Proportional Band is a user-defined range that is divided into two equal parts for cooling and heating. The Temperature Setpoint is between these two equal parts.

An optional Temperature Deadband range can be defined, which is equally divided on either side of the setpoint and separates the two halves of the proportional band. **Figure 11** illustrates how the temperature proportional band is evenly divided on either side of the temperature setpoint, with and without a deadband.

Figure 11 Temperature proportional band

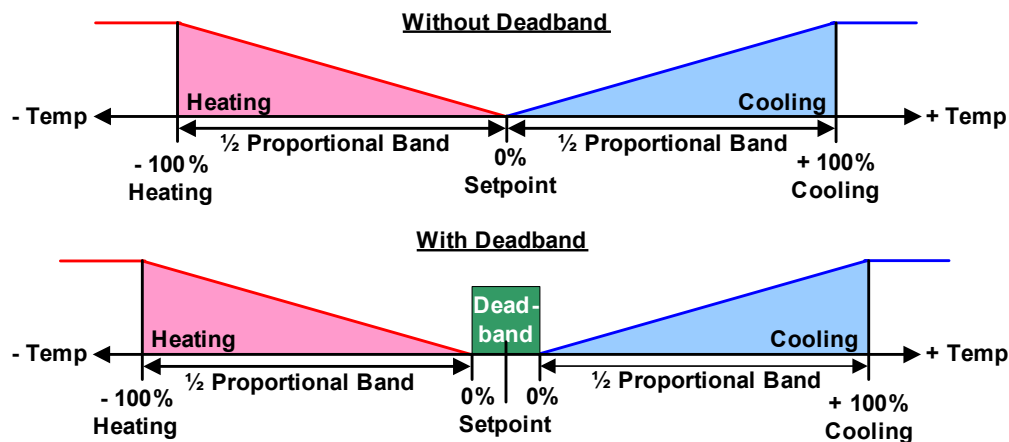

When the return air temperature deviates from the setpoint it begins to penetrate one of the proportional band halves, cooling or heating. If the return air temperature increases, the control calls for 0% (none) to 100% (full) cooling capacity based on how far the temperature penetrates the cooling portion of the proportional band. If the return air temperature decreases, the control calls for 0% (none) to -100% (full) heating capacity based on how far the temperature penetrates the heating portion of the proportional band.

When the return air temperature reaches the end of the proportional band, either 100% or -100%, full cooling or full heating capacity is provided. No operation is performed when a 0% call is calculated. The control varies the call for cooling and heating in 1% increments as the return air temperature moves through the proportional band halves.

The deadband range is used to widen the setpoint. When the return air temperature falls within the deadband, the control operates the same as if the temperature equaled the setpoint exactly. This setting helps maximize component life by preventing excessive component cycling. The Temperature Proportional Band and Temperature Deadband parameters are in the Service menu under the Setpoints submenu. The Temperature Setpoint parameter is in both the User menu and Service Menu under Setpoints.

There is a parameter AutoSet Enable (Service Menu, Setpoints), which automatically sets the proportional bands for temperature and humidity, and both the integration time factors according to the type of unit (Chilled Water, single or double compressor), with influence of the selected Teamwork Mode. See 4.1 - **Teamwork Modes** for more on using this feature.

3.2.2 Compressor Control

Depending on the type of Liebert air conditioning unit you have your unit may contain one or two compressors with or without unloaders.

Compressor Proportional Bands

One Single-Step Compressor Without Unloaders—One-Step

One single-step compressor, Cool 1, is started at 100% call for cooling from the temperature proportional band and stopped at 0% (see **Figure 12**).

Figure 12 One single-step compressor without unloaders

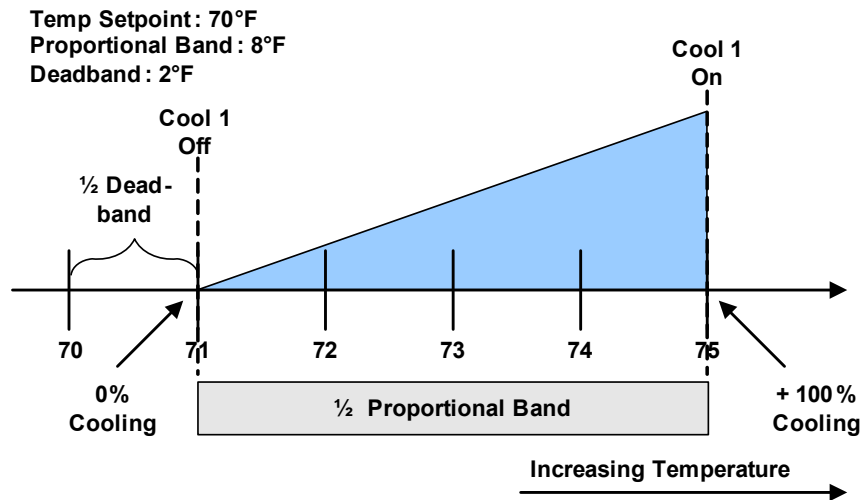

Two Single-Step Compressors Without Unloaders—Two-Step

First single-step compressor, Cool 1, is started at 50% calculated output from the temperature proportional band, and stopped at 0%. The second compressor, Cool 2, starts at 100% and stops at 50% (see **Figure 13**).

One Compressor With an Unloader—Two-Step

The two-step compressor is started unloaded at 50%, Cool 1, calculated output from the temperature proportional band and stopped at 0%. At 100% the compressor starts fully loaded, Cool 2, and returns to unload operation at 50% (see **Figure 13**).

Figure 13 Two single-step compressors without unloaders or one compressor with an unloader (two-step)

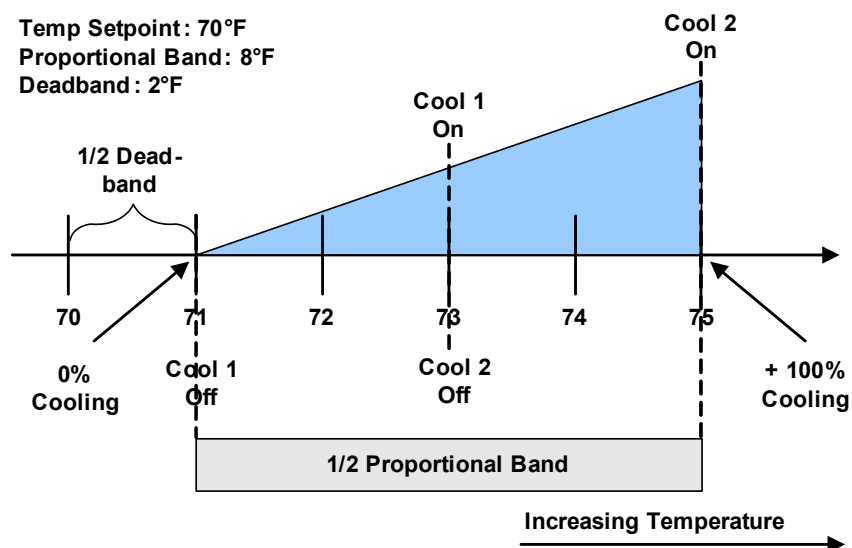

Two Compressors With Unloaders—Four-Step

The first two-step compressor is started unloaded at 33% calculated output from the temperature proportional band and stopped at 17%. At 80% Compressor 1 will be loaded, at 70% unloaded.

The second compressor starts unloaded at 63% and stops at 47%. At 100%, Compressor 2 will be loaded, at 90% unloaded (see **Figure 14**).

The four stages of cooling are accomplished in the following manner:

- 1 stage: One compressor, unloaded - Cool 1
- 2 stages: Both compressors, unloaded - Cool 2
- 3 stages: One compressor, loaded and one compressor, unloaded - Cool 3
- 4 stages: Both compressors, loaded - Cool 4

Figure 14 Two compressors with unloaders (four-step)

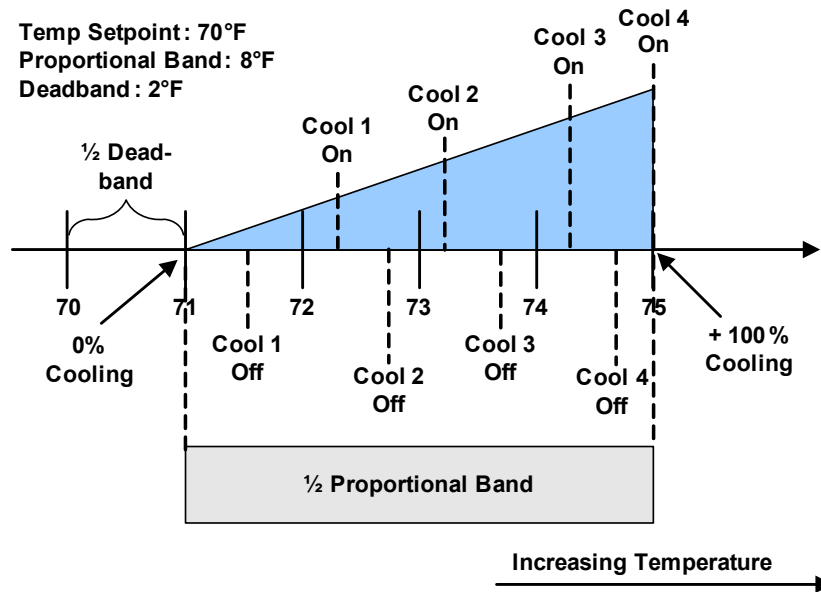

Digital Scroll Compressors

A compressor with a suction cutoff unloader can only modulate its capacity between two distinct levels: fully loaded and half loaded. A digital scroll compressor can modulate its capacity anywhere between 10-100%. This variable capacity modulation allows cooling units to control an environment more precisely.

Digital scroll capacity modulation is achieved by energizing and de-energizing a solenoid valve on the compressor. When the solenoid valve is de-energized, the compressor capacity is 100%. When the solenoid valve is energized, the compressor capacity is zero. Therefore, the capacity of the compressor depends on how long the solenoid is de-energized for. If the solenoid is de-energized for 10-seconds, then energized for 5 seconds during a 15-second cycle, the resulting capacity will be 66% as shown in Figure 15.

Figure 15 Digital scroll capacity modulation, 10-100% variable

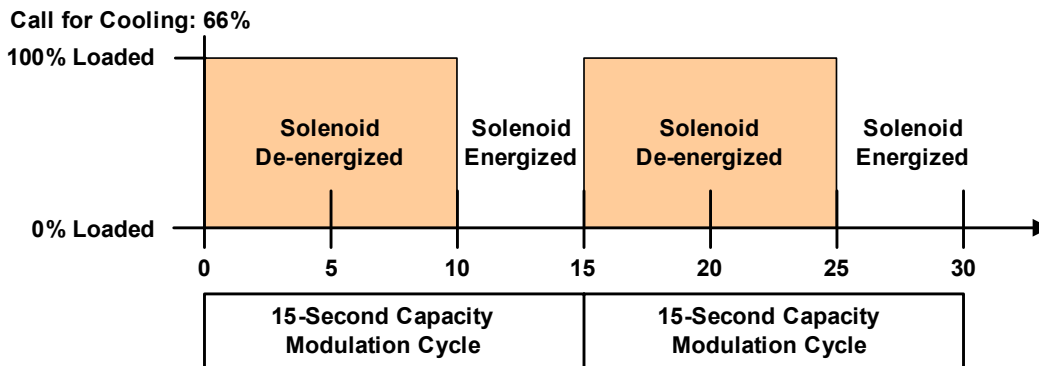

On single and dual digital scroll compressor systems, the first compressor is started at 25% calculated output from the temperature proportional band and stopped at 10%. On dual digital scroll compressor systems, the second compressor is started at 35% and stopped at 20%, see Figure 16. When a compressor is started, the solenoid is energized longer than it is de-energized to match the call for cooling. When the call for cooling increases to 100%, the solenoid is de-energized for the entire 15 second cycle.

Figure 16 Single and dual digital scroll compressor activation points

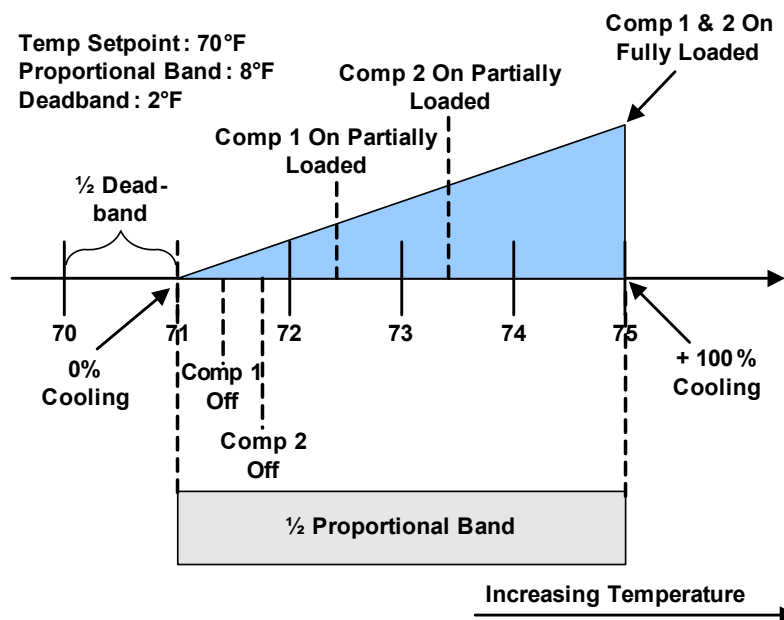

3.2.3 Chilled Water Control

The chilled water control valve is adjusted proportionally as the temperature control varies the requirement for cooling from 0% to 100%. Units with the optional variable speed drive (VSD) control the fan speed in a similar manner, except that the minimum fan speed is 60% when the cooling requirement is less than 60%. Also, the fan is operated at 100% on a call for any heating and/or humidification.

A three-point actuator is used for chilled water cooling, as well as free cooling, or heating, with either valves or dampers. These actuators are driven through two digital outputs: Open and Close.

The Three-Point Actuator Running Time (Service Menu, Options Setup) defines the time needed to move the valve or damper from closed to open. The Actuator Direction (Service Menu, Options Setup) defines if the valve/damper works in direct or reverse mode (the controller outputs are exchanged; Open becomes Close and Close becomes Open).

Any time the unit receives the Power On signal, the valve performs a 3P Reset: the Close command is given continuously for a time of 110% of the 3P actuator run time. This calibrates the valve or damper with the controller and ensures that it is closed. A 3P Reset is also performed if the fan is switched off for any reason (timer off, unit off, etc.).

During normal operation the 3P actuator is driven in steps. After start of control (unit on or free-cooling / glycol cooling is enabled) the 3P actuator moves (without stepping) to the requested position, after that the stepping starts.

Figure 17 Three-point actuator control (example: cooling)

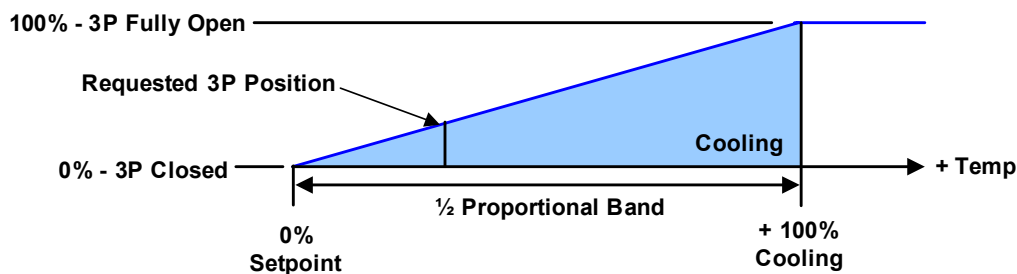

3.3 Temperature Control—Second Cooling Source

Certain cooling units are available with a second source of cooling within the unit. These typically are compressorized models with an additional chilled water or free-cooling coil.

3.3.1 Differential Temperatures / Controls (Comparator Circuit)

Delta T (Temperature Difference) Between Room and Glycol

The comparator circuit determines if the glycol / chilled water temperature of the second cooling source is low enough to provide at least partial cooling capacity. The comparator circuit has three settings (DT Between Room / FC Type, [Service Menu, Setpoints]):

- No
- Contact
- Value

The No setting is for standard compressorized and chilled water units that do not have a second cooling source. The Contact setting is used when an external control is being used to determine when the second cooling source is to be activated. The external control communicates to the Liebert unit via a contact closure

- Closed = cooling enabled
- Open = cooling disabled.

The Value setting is the factory default setting on free-cooling and dual cooling units. If the temperature difference between the second source cooling fluid parameter, Free-cooling Fluid Temperature (User Menu, Sensor Data) and room air is equal to or greater than the adjustable DT Between Room Air / FC Fluid (Service Menu, Setpoints) value, then the second source cooling fluid will be used to provide at least partial cooling (delta T between room and glycol = true).

Sensors used for this delta T are: room/local sensor or the return air sensor; and the glycol sensor.

If this delta T is true, the following actions will be performed:

1. The Free-Cooling Status indication will show “On” instead of “Off”.
2. The compressor band will be shifted to the right by 100%, and within the first 100% the free-cooling valve band will take place (see **Figure 18**).

Figure 18 Second cooling source and compressorized cooling

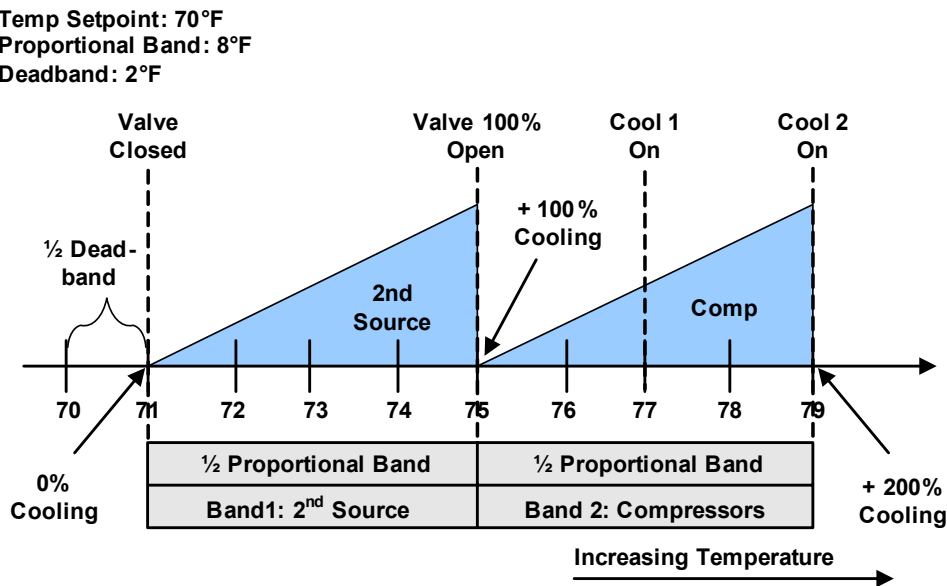

Minimum Chilled Water Temperature—This feature permits the user to select the minimum chilled water temperature that allows simultaneous operation of the second cooling source (chilled water control) and compressor control. This feature is enabled in the Service menu under Setpoints, parameter Minimum CW Temp.

Below this minimum chilled water setpoint, parameter Minimum CW Temp Value, (Service Menu, Setpoints), the control will operate ONLY the second cooling source control, i.e., the compressor is locked out. Above the minimum chilled water setpoint, assuming the fluid temperature is below the return room air temperature (delta T between room and glycol = true), the control will operate the second cooling source control and compressor control simultaneously if needed.

If the Minimum CW Temp is disabled, the second cooling source temperature is ignored, the control will always operate the second cooling source and compressors simultaneously when the load requires it.

GLYCOOL™ Cooling—Free-Cooling

When GLYCOOL cooling is available, the temperature control will calculate a total cooling requirement of 200% rather than 100%. Assuming that full GLYCOOL capacity is available, the GLYCOOL valve opens proportionally as the requirement for cooling rises from 0 to 100%. If more than 100% cooling is required, then the compressors are activated at 150% and 200% respectively (133%, 163%, 180% and 200% for a four-step system). If full GLYCOOL capacity is not available, then the GLYCOOL valve will be opened proportionally over a cooling requirement band equal to the available GLYCOOL capacity. The compressors would be activated when the GLYCOOL capacity is exceeded.

For example, if the GLYCOOL capacity is 60%, then the GLYCOOL valve would be full open at 60% cooling requirement and the compressors would activate at 110% and 160% cooling requirement. In order to reduce compressor cycling and prevent hunting, GLYCOOL capacity first becomes available when the entering glycol temperature is at least 8°F (-13°C) (22% capacity) below the return air temperature, or 3°F (-16°C) below the return air temperature for two hours. GLYCOOL capacity is 100% when the glycol temperature is 25°F (-4°C) below the return air temperature. The system will continue to operate in Econ-O-Cool mode as necessary as long as the entering glycol temperature remains at least 3°F (-16°C) (0% capacity) below the return air temperature. If GLYCOOL is not available, the temperature control will operate the compressors in the same manner as a two-step or four-step system without GLYCOOL.

Dual Cooling Source

If dual cooling is available, the sensible cooling system operates in the same manner as a GLYCOOL system, except that it is assumed that 100% chilled water capacity is available any time the chilled water temperature is 3°F (-16°C) below the return air temperature.

3.4 Temperature Control—Reheat

If the room air temperature becomes too cold, the control will call for heating. Heating mode is controlled by the Temperature Proportional Band, explained in **3.2.1 - Temperature Proportional Band**.

3.4.1 Three-Stage Electric, Hot Gas and Hot Water Reheat

The Reheat Proportional Band is divided into three equal parts, each representing one reheat stage. As the Temperature Proportional Band increases the call for heating from 0% to -100%, stages 1 through 3 are switched On, as shown in **Figure 19**. Your unit will have one of the nine reheat configuration types shown in **Table 4**.

Table 4 Reheat configuration types

Type	A	B	C	D	E	F	G	H	I
Stage 1	Electric 1	Electric 1	Electric 1	Hot Gas	Hot Gas	Hot Gas	Hot Water	Hot Water	Hot Water
Stage 2	-	Electric 2	Electric 2	-	Electric 1	Electric 1	-	Electric 1	Electric 1
Stage 3	-	-	Electric 3	-	-	Electric 2	-	-	Electric 2



NOTE

1. Hot gas / hot water are not influenced by the setting of electric reheat during dehumidification.
2. Hot gas output will be set only if the selected compressor is in operation.

Figure 19 Three-stage heating

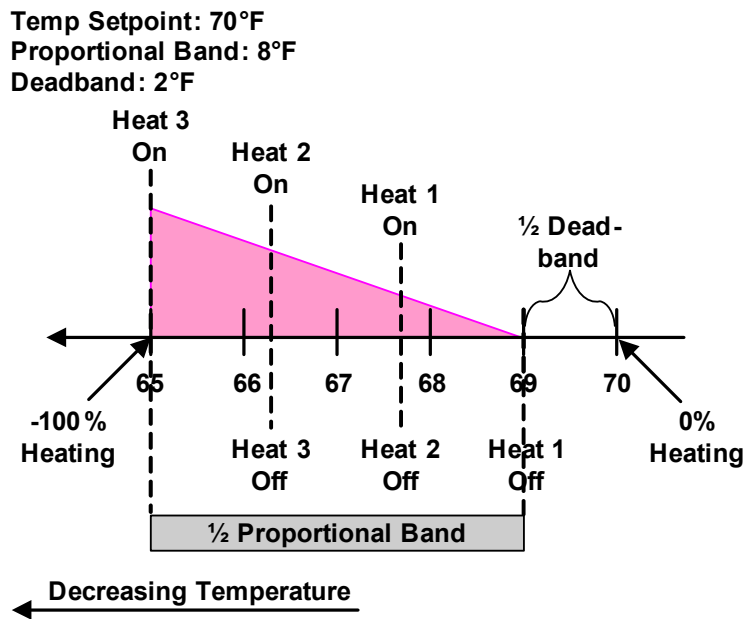

3.4.2 SCR Reheat

SCR reheat is a type of electric reheat that provides tighter temperature control than staged electric reheat. SCR reheat capacity modulation is achieved by pulsing the reheat On and Off. Full capacity is achieved by constantly energizing the reheat. Units equipped with SCR reheat can operate in Tight or Standard mode. By default, cooling units with SCR reheat are factory-set to operate in Tight mode. The mode of operation can be set by adjusting the SCR Control Type parameter (Service Menu, Set-points).

Tight Mode

In Tight mode, the compressors and reheats are operated at the same time to provide maximum temperature control. The temperature deadband is set to zero at the factory. In a cooling unit with SCR reheat and two single-step compressors, the first single-step compressor is started and full reheat capacity is provided at 0% calculated output from the Temperature Proportional Band. As the call for cooling increases from 0% to 100%, the reheat capacity is slowly reduced by pulsing the reheat. At 100% call for cooling, the reheat is deactivated and the second single-step compressor is started. As the call for cooling is reduced, the reheat capacity is slowly increased. When the call for cooling returns to 0%, the second single-step compressor is deactivated.

If the Temperature Proportional Band calculates a call for heating from 0% to -200%, the first single-step compressor remains activated and full reheat capacity is provided. Based on the factory default settings, the first single-step compressor is deactivated when the control reaches -200% call for heating. The compressor remains deactivated until the control calls for 0% heating. The compressor activation and deactivation points can be adjusted in the Service menu under Setpoints.

Figure 20 illustrates how a cooling unit with two single-step compressors and SCR reheat operates when the SCR Control Type is set to Tight mode.



NOTE

Some cooling units are not suited for a strict NO LOAD application. These cooling units require a minimal load in the space. Consult factory for verification.

Figure 20 Two single-step compressors with SCR reheat set to Tight mode

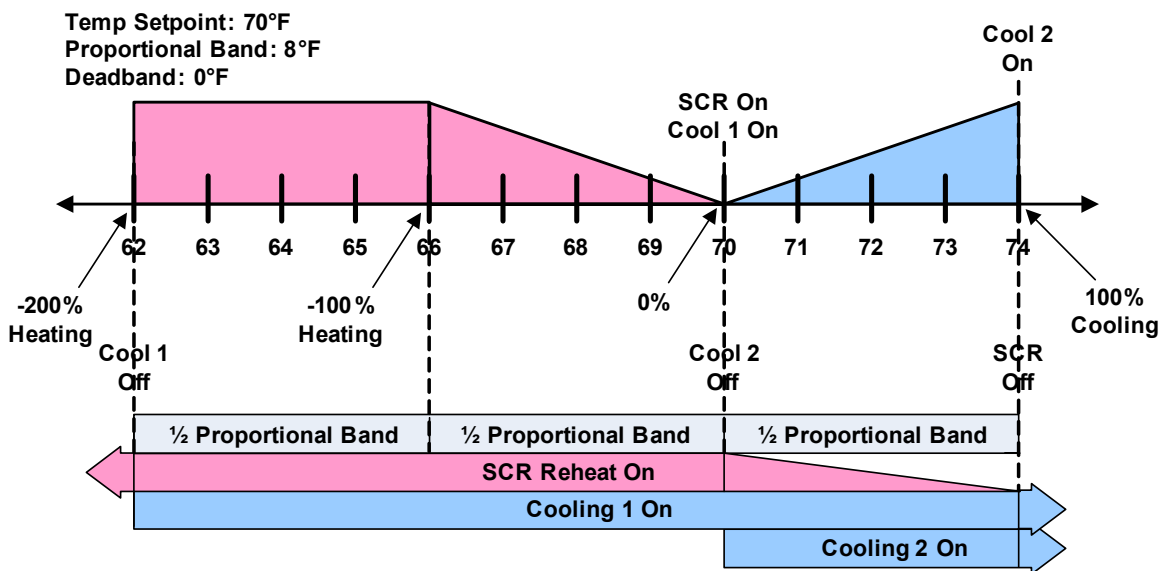

Standard Mode

In Standard mode, the SCR reheat operates only when the Temperature Proportional Band calls for heating. SCR reheat output is adjusted proportionally as the Temperature Proportional Band varies the requirement for heating from 0% to -100%. Compressors operate only when there is a call for cooling as described in **3.2.2 - Compressor Control**.

Figure 21 illustrates how SCR reheat operates when SCR Control Type is set to Standard mode.

Figure 21 Two single-step compressors with SCR reheat set to Standard mode

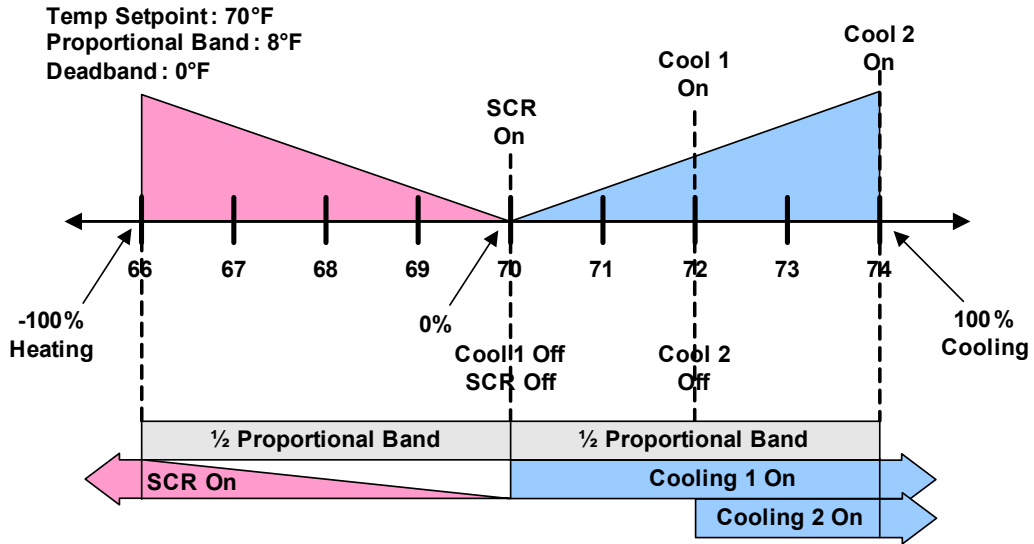

3.5 Humidity Control

The control uses the humidity proportional band to determine which operation to perform (dehumidification/humidification) and how intensely to perform it. The Humidity Proportional Band is a user defined range that is divided into two equal parts for dehumidifying and humidifying. The Humidity Setpoint is located between these two equal parts.

An optional Humidity Deadband range can be defined, which is equally divided on either side of the setpoint and separates the two halves of the proportional band. **Figure 22** illustrates how the humidity proportional band is evenly divided on either side of the humidity setpoint, with and without a deadband.

Figure 22 Humidity proportional band

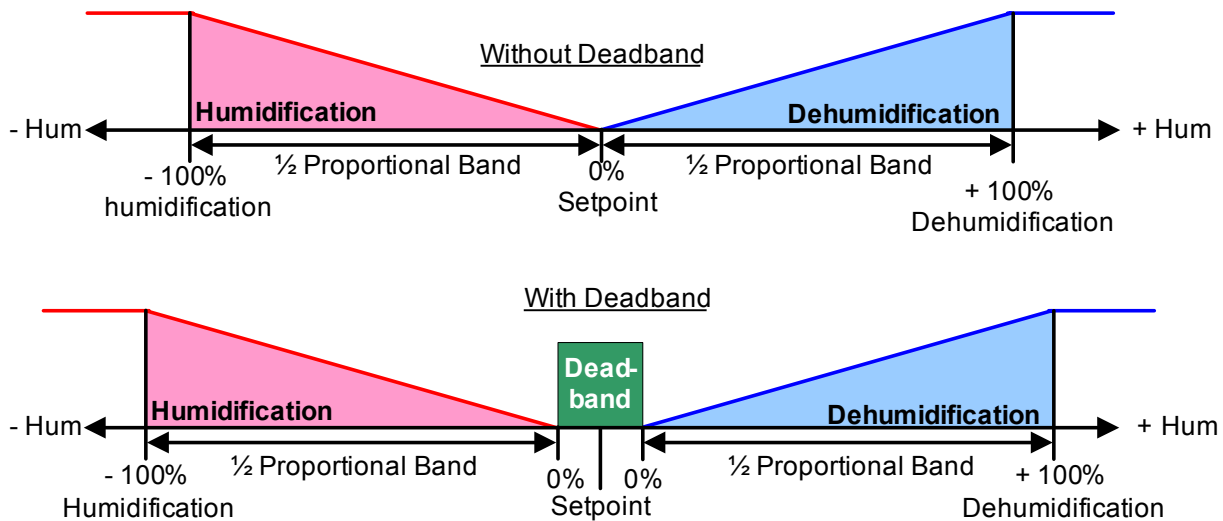

When the return air humidity deviates from the setpoint, it begins to penetrate one of the proportional band halves, either dehumidification or humidification. If the return air humidity increases, the control calls for 0% (none) to 100% (full) dehumidifying capacity, based on how far the humidity penetrates the dehumidification portion of the proportional band. If the return air humidity decreases, the control calls for 0% (none) to -100% (full) humidifying capacity based on how far the humidity penetrates the humidification portion of the proportional band.

When the return air humidity reaches the end of the proportional band, either 100% or -100%, full dehumidification or full humidification capacity is provided. No operation is performed when a 0% call is calculated. The control varies the call for dehumidifying and humidifying in 1% increments as the return air humidity moves through the proportional band halves.

The deadband range is used to widen the setpoint. When the return air humidity falls within the deadband, the control operates the same as if the humidity equaled the setpoint exactly. This setting helps maximize component life by preventing excessive component cycling. The Humidity Proportional Band and Humidity Deadband parameters are in the Service menu under the Setpoints sub-menu. The Humidity Setpoint parameter is in both the User menu and Service menu under Setpoints.

3.5.1 Humidification

Infrared Humidifier

There are two types of infrared humidifiers: small pan (IFS) and large pan (IFL). The operating mode of each is similar, however, some of the variables or timings differ.

Infrared humidifiers are started at 100% humidification request, and stopped at 0%. Infrared humidifiers cannot be driven in proportional mode.

Table 5 Parameters for infrared humidifier control

Parameter	IFS Default	IFL Default
Humidity in Last xx Hours	15 hours	15 hours
Prefill Time	30 seconds	60 seconds
Fill Time	4 minutes	7 minutes
Humidifier On Time	8 or 10 minutes	10 minutes
Flush Rate	150%	150%

An autoflush system automatically controls a water makeup valve to maintain proper levels in the infrared humidifier water pan during humidifier operation. If humidification is needed and 15 hours have elapsed since the last time the humidifier was on, then the humidifier is not turned on until the valve completes an initial fill of the humidifier pan. This pre-fill is about 30 seconds for a small pan and 60 seconds for a large pan. The valve continues to fill and flush the pan for about 4-1/2 minutes for a small pan or 7-1/2 minutes for a large pan. Pan size is selected based on unit specifications and is preset at the factory.

During humidifier operation, with the flush rate set at the default of 150%, the valve is opened periodically to add water to the pan (about 45 seconds every 7 minutes of humidifier operation for a small pan, or 80 seconds every 10 minutes of operation for a large pan). This adds enough water to the pan to cause about a third of the total water used to be flushed out of the overflow standpipe located in the humidifier pan. This action helps to remove solids from the pan. The flush rate is adjustable from 110% to 500% in 10% intervals. Default is 150%. If the water quality is poor, it may be desirable to increase the water flushing action above the normal 150% rate. Also, if the supply water pressure is low, the flush rate adjustment can be increased so that sufficient water level is maintained during humidification. The flush rate parameter, Infrared Flush Rate (Service Menu, Options Setup), is adjustable from 110%-500%.

External Humidifier Control—Optional

A factory-supplied option may be provided to allow a start-stop command to be sent to the control of a remote-mounted humidifier.

3.5.2 Dehumidification

The Dehumidification Enable parameter (Service Menu, Options Setup) allows for enabling/disabling the dehumidification function.

A call for dehumidification is calculated in the same way as a cooling request. The components (valves, compressors) will follow this dehumidification request as soon as it is higher than the request for cooling.

Dehumidification Low Limit

Low Limit 1 and Low Limit 2 are used to avoid overcooling a room during dehumidification. When a low limit is reached, a compressor or the liquid cooling source that is used for dehumidification is disabled. It is re-enabled when the return air temperature rises. The Low Limit 1 and 2 settings are in the Service menu under Setpoints.

Low Limit 1: Low Limit 1 will disable one of two compressors for dehumidification. If only one compressor is set for dehumidification, or if the dehumidification source is chilled water, this limit will not be visible and will be inactive.

Low Limit 2: Low Limit 2 will disable both compressors for dehumidification. This limit will also stop dehumidification in single compressor units and in chilled water units.

The limits become active when the return air temperature drops below a temperature value equal to the sum of the temperature setpoint plus the value set on Low Limit 1 and 2 (the Low Limit settings are negative values).

A dehumidification source is deactivated if the return air temperature drops below the Deactivation Temperature, as in this example:

Temperature Setpoint: 70°F
 Low Limit Value: -7°F
 Deactivation Temperature: 62°F



NOTE

If a cooling unit is equipped with SCR reheat and the SCR Control Type parameter is set to Tight mode, then Low Limit 2 will be ignored, see 3.4 - Temperature Control—Reheat.

Dehumidification Compressor Quantity

Under Factory Settings in the Advanced menu there is an item called Dehumidification With Comp. This item will be set to either 1, 2, 1 or 2, or BOTH. This setting determines which compressors are used for dehumidification. It also determines if Low Limit 1 will be available and impacts how the reheats will operate during dehumidification. The Dehumidification With Comp field is set when the cooling unit is built and should not be adjusted without consulting the factory first. **Table 6** outlines which Low Limit settings will be available, based on the Dehumidification With Comp selection.

Table 6 Dehumidification With Comp settings

Available to Set Value	Dehumidification With Comp Setting	Default Setting On
Low Limit 2 only	[blank] (units without compressors)	All Chilled Water Units
	1 (Compressor 1 dehumidifies only)	Liebert Challenger 3000™ Liebert DS™, Liebert Deluxe System/3™
	2 (Compressor 2 dehumidifies only)	—
	1 or 2 (Compressor 1 and 2 alternate)	—
Low Limit 1 & 2	Both (both compressors dehumidify)	—

Low Limit 1 & 2 will be available only on cooling units with two compressors when Dehumidification With Comp is set to BOTH (see **WARNING on page 29**).

Reheat During Dehumidification

Hot gas reheat or hot water reheat will start as described in **3.4 - Temperature Control—Reheat**, when the temperature decreases during the dehumidification process.

The parameter Electric Reheat Operation defines how the heaters react in case the temperature decreases during the dehumidification process. This parameter does not impact SCR reheat operation. The Electric Reheat Operation parameter is in the Advanced menu under Factory Settings and should not be adjusted without factory approval.

No—No electric reheat allowed during dehumidification process.

Delayed—This setting applies only to two-compressor units with BOTH compressors selected for dehumidification. The electric reheats are prevented from turning on until Low Limit 1 is reached. At this condition, one stage of dehumidification is disabled and the reheats are activated. At Low Limit 2, both stages of dehumidification are disabled. When Delayed is selected on units with a single compressor selected for dehumidification (Dehumidification With Comp Setting: 1, 2, and 1 or 2), the reheats will operate in the same manner as they do for Staged as described below. Delayed is the default setting for Liebert DS units.

Staged—This setting applies to one or two compressor units. Electric heaters will stage as described in **3.4.1 - Three-Stage Electric, Hot Gas and Hot Water Reheat**. Staged is the default setting for Challenger 3000 units. On two compressor units with staged reheat selected and Dehumidification With Comp set to BOTH, the control allows for operating two compressors and reheats simultaneously. It is very important that electrical service to the unit be sized and wired for this option if selected.



WARNING

If the electrical service to the unit is not properly sized, it could trip the building circuit breakers (or fuses) or, in extreme cases, damage the building wiring. This Warning applies only when the Dehumidification With Comp is set to BOTH and the Electric Reheat Operation is set to Staged. Consult factory before making any changes to the default settings.

3.6 Control Types

3.6.1 Temperature and Humidity Control Types

The Liebert iCOM control has four Temperature and Humidity Control Types: Proportional, PI and Intelligent. Each control type affects the timing and intensity of the cooling/heating and humidifying/dehumidifying operations. The Control Type parameter is in the Service menu under Setpoints.

Proportional – If Proportional Control is selected, the percent cooling/heating requirement is determined by the difference between the return air temperature sensor reading and the temperature setpoint. As the return air temperature rises above the temperature setpoint, the percent cooling required increases proportionally (from 0 to 100%) over half the programmable temperature proportional band (See **3.2.1 - Temperature Proportional Band**). The percent heating requirement (0 to 100%) is determined the same way when the return air temperature falls below the setpoint. The humidifying/dehumidifying operations are controlled in the same manner as the cooling/heating operations; however, the humidity sensors, setpoints and proportional bands are utilized. The Proportional control type is commonly selected on compressorized units.

PI – If PI Control is selected, the percent cooling/heating requirement is calculated by adding together two individual terms – proportional and integral. The proportional term is calculated in a manner similar to the previously described Proportional control. The integral term (sometimes called “reset action”) is calculated by measuring how much and for how long the return air temperature/humidity has been above or below the setpoint. If the actual return air temperature/humidity is above the setpoint, the percent requirement is slowly but continuously increased until the total is sufficient to bring the return room air back to the setpoint. This control type is commonly selected on free-cooling and dual-cool units.

Intelligent – If Intelligent Control is selected, the return air temperature/humidity is controlled at or near the setpoint. The percent temperature/humidity adjustment required is calculated based on logic that is programmed into the control. These rules simulate the actions that a human operator would take if manually controlling the system. This control type is commonly selected on chilled water units.

**NOTE**

The actual return air temperature sensor reading is always displayed on the Status menu. The value displayed for the return air humidity sensor reading depends on the Humidity Sensor Control Type (see 3.6.2 - Humidity Sensor Reading Control Types).

3.6.2 Humidity Sensor Reading Control Types

The Liebert iCOM control has three humidity sensor control types: Relative, Compensated and Predictive. The humidity sensor control adjusts how the Temperature and Humidity Control determines the percent requirement for humidification/dehumidification. The humidity sensor control type parameter, Humidity Control Type, is in both the User and Service menus under Setpoints.

Relative—The actual return air humidity sensor reading is sent to the Temperature and Humidity Control to determine if and how much humidification/dehumidification is required. The actual return air humidity reading is displayed on the Status menu. Unnecessary dehumidification can result when overcooling occurs during a dehumidification cycle. This is because a higher than normal relative humidity (RH) reading is caused by overcooling the room. This extends the dehumidification cycle. Later, when the dehumidification ends and the return air temperature rises to the setpoint, the RH reading falls. The final RH reading will then be lower than actually desired. If significant overcooling occurred, the RH could be low enough to activate the humidifier.

Compensated—The actual return air humidity sensor reading is sent to the Temperature and Humidity Control where the Humidity Setpoint is adjusted based on how much the return room air temperature deviates from the desired temperature setpoint. The adjusted humidity setpoint is used for humidification percent requirement determination. For every 1°C deviation from the temperature setpoint the humidity setpoint is changed by 3% RH, inversely proportional: if the temperature increases, the humidity setpoint is decreased, and vice versa. The recalculated humidity setpoint is shown as the Actual Humidity Setpoint (User Menu, Sensor Data). As the humidity setpoint is automatically adjusted, the high and low humidity setpoints (User Menu, Set Alarms) are adjusted accordingly. The unadjusted humidity sensor reading is displayed on the Status menu.

Predictive—The actual return air humidity sensor reading is adjusted before it is sent to the Temperature and Humidity Control. The humidity sensor reading is adjusted based on how much the return room air temperature deviates from the desired temperature setpoint. For every 1°C deviation from the temperature setpoint, the humidity sensor reading is changed by 3% RH, directly proportional: if the temperature increases, the humidity reading is increased and vice versa. The adjusted humidity sensor reading is displayed on the Status menu. Units are shipped from the factory with Predictive humidity control set as default.

If Compensated or Predictive humidity sensor control is selected, overdehumidification is avoided. When overcooling occurs, causing an increase in the relative humidity sensor reading, the humidity control program predicts what the RH will be when the dehumidification cycle ends and return air temperature returns to the setpoint. This allows the dehumidification cycle to end at the proper time. The Compensated and Predictive humidity sensor control can reduce energy consumption by minimizing compressor and reheat operation, and eliminating unnecessary humidifier operation.

**NOTE**

The historical humidity sensor graphs will display the real (unadjusted) sensor readings, no matter which Humidity Control Sensor Type is selected. The graphical sensor data is in the User menu under Graphics.

3.6.3 Supply Limit—Optional

Chilled water units may be ordered with an additional sensor for monitoring the supply air temperature. This sensor maintains the minimum air temperature under a raised floor to help prevent condensation from forming. In order to avoid supply temperatures that are too low, the Supply Limit can influence the opening of three-point or analog actuators or the output of analog values.

The control compares the deviation from the return air setpoint and the supply limit setpoint, and calculates the output to the actuator from the smaller deviation.

**NOTE**

The Supply Limit is calculated on each unit, independent of the other sensor readings on the network.

3.6.4 High and Low, Temperature and Humidity Events

High- and low-temperature and humidity alarms can be set for both the internal and optional external sensors. If a sensor reading exceeds a preset threshold, a warning will appear. These warnings are ignored after unit startup for a minimum of 1 minute. To increase the delay to warn, see **3.6.6 - Event Types and Properties**. The threshold settings are located in both the User and Service menus under Set Alarms.

To apply threshold limits on the internal cooling unit sensors, the Return Sensor Alarms must be enabled. The high and low temperature and humidity internal sensor thresholds can then be set. To apply threshold limits on the optional external sensors, the Sensor A alarms must be enabled. The high and low temperature and humidity external sensor thresholds can then be set. If no external sensors are connected to the unit, it is recommended that the Sensor A Alarms be disabled.

**NOTE**

There is an auto-reset of the event messages if the temperature/humidity constantly stays 1.8°F (1°C)/ 2% RH below or above the threshold for a time of one minute.

3.6.5 User Inputs / Customer Inputs

The user can connect and specify up to four inputs depending on unit configuration. The user inputs/customer inputs are digital inputs that influence the operating mode of the unit depending on the selection. The customer input configuration settings are in the Service menu under Set Alarms, Screen 2 of 7. The choices for the customer inputs are shown in **Table 7** along with their associated reaction. A terminal strip is provided in the cooling unit to connect your contact closure to. You have the ability to set the control to react on an open or closed contact.



NOTE

*To enabled/disabled, delay activation and set event type (alarm, warn, message) see **Event Types on page 33.***

Table 7 Customer inputs

Setting	Reaction
Smoke	Event Only
Water Alarm	Event Only
C PMP Alarm	Event Only
Flow Alarm	Event Only
Stdby G Pmp	Event Only
Stdby Unit	Event Only
C-Input 1	Event Only
C-Input 2	Event Only
C-Input 3	Event Only
C-Input 4	Event Only
Rht Lockout	Event + Electrical Heaters Disabled
Hum Lockout	Event + Humidifier Disabled
Rht+Hum Lock	Event + Electrical Heaters and Humidifier Disabled
Comp Lockout	Event + Compressor(s) Disabled w/o Pump Down
Call Service	Event Only
High Temp	Event Only
Air Loss	Event Only
FC Lockout	Event + Free Cooling Disabled
Heater Alarm	Event + Heaters Off (PeX Only)
Flow AL SD	Event + Shut Down the Unit
Flow AL LC	Event + Lockout Compressors, No Pump Down (enabled only if at least one compressor is on; auto-reset depends on input status)
Comp Lock PD	Event + Compressor(s) Disabled w/ Pump Down
Enable FC	Forces Free Cooling to On
HTRJ VFD	Activates the HEAT REJ VFD ALARM; no other function
HTRJ TVSS	Activates the HEAT REJ TVSS ALARM; no other function

3.6.6 Event Types and Properties

Liebert iCOM events are used to inform the user of cooling unit operational status. All events are recorded in the Event Log, which is in the User Menu. The user can change the type (alarm, warn, message) and time delay of some events and can also enable or disable some events. These event settings are in the Service Menu under Set Alarms, pages 3 to 7. If an event has a safety function (high pressure, low pressure, main fan overload, etc.) the safety function will be executed in any case, independent of the selected event type or if enabled or disabled. The timing will function as set.



NOTE

Not all critical event properties can be adjusted.

Event Types

- **Message:** If this event occurs, it will only be entered into the event log.
- **Warning:** If this event occurs, a warning will be generated and entered into the event log. The general alarm relay will be activated only if parameter Warning Activates Alarm Relay located in the Service menu under Alarm Setup is set to Yes (Yes is the default setting from the factory)
- **Alarm:** If this event occurs, an alarm will be generated and entered into the event log. An alarm does not necessarily switch off the whole cooling unit; it depends on which alarm occurs. If a standby unit is set, any alarm will stop the faulty unit and ask the standby unit to start. Standby activation is achieved on alarms ONLY; messages or warnings will not start the standby unit. For more on standby units, see **4.0 - Teamwork**.

Time Delay

Delays the event reaction once it is triggered. The time delay applies to safety functions and is entered in seconds.

Enable or Disable

Disabled events do not show up in the event log, on the display or on monitoring devices. Also, the common alarm relay will not be activated if a disabled alarm occurs. Safety functions, such as lockout compressor in case of high pressure are still performed.



NOTE

Once a disabled event (set to Warn or to Alarm) becomes active, it will lock itself. Disabled events may be reset only through the menu item Reset Disabled Alarms.



NOTE

*The value of the external delay includes the internal delay:
external delay = setting – internal delay.*

*The minimum setting of the external delay is the value of the internal delay. This is valid only for values marked with *.*

Table 8 Possible event settings—some events not available in all units

Event	Internal Delay (Before Action Occurs)	Default Delay / Selectable (Before Action Occurs)	Type (default)
MAIN FAN OVERLOAD	2 seconds	5 seconds / 0 – 9999 *	ALM
LOSS OF AIRFLOW	3 seconds	3 seconds / 0 – 9999 *	ALM
CLOGGED FILTERS	2 seconds	2 seconds / 0 – 9999 *	WRN
HIGH ROOM TEMP	1 Min After Fan On	30 seconds / 0 – 9999	Fixed to WRN
LOW ROOM TEMP	1 Min After Fan On	30 seconds / 0 – 9999	Fixed to WRN
HIGH ROOM HUM	1 Min After Fan On	30 seconds / 0 – 9999	Fixed to WRN
LOW ROOM HUM	1 Min After Fan On	30 seconds / 0 – 9999	Fixed to WRN
HIGH TEMP SENSOR A	1 Min After Fan On	30 seconds / 0 – 9999	Fixed to WRN
LOW TEMP SENSOR A	1 Min After Fan On	30 seconds / 0 – 9999	Fixed to WRN
HIGH HUM SENSOR A	1 Min After Fan On	30 seconds / 0 – 9999	Fixed to WRN
LOW HUM SENSOR A	1 Min After Fan On	30 seconds / 0 – 9999	Fixed to WRN
COMP 1 OVERLOAD	Internal Calc.	no	ALM
COMP 2 OVERLOAD	Internal Calc.	no	ALM
COMP 1 HIGH PRESSURE	Internal Calc.	no	ALM
COMP 2 HIGH PRESSURE	Internal Calc.	no	ALM
COMP 1 LOW PRESSURE	Internal Calc.	no	ALM
COMP 2 LOW PRESSURE	Internal Calc.	no	ALM
COMP 1 PUMPDOWN FAIL	Internal Calc.	no	ALM
COMP 2 PUMPDOWN FAIL	Internal Calc.	no	ALM
DIG SCROLL1 HIGH TEMP	Internal Calc.	no	ALM
DIG SCROLL2 HIGH TEMP	Internal Calc.	no	ALM
EL HEAT HIGH TEMP	5 Sec	0 sec / 0 – 9999	WRN
WORKING HRS EXCEEDED	0 Sec	0 sec / 0 – 9999	Fixed to WRN
SMOKE DETECTED	2 Sec	2 sec / 0 – 9999 *	ALM
WATER UNDER FLOOR	2 Sec	2 sec / 0 – 9999 *	ALM
COND PUMP-HIGH WATER	2 Sec	2 sec / 0 – 9999 *	ALM
LOSS OF FLOW	5 Sec Reset Delay: 10 Sec	2 sec / 0 – 9999 *	ALM
STBY GLYCOL PUMP ON	2 Sec	2 sec / 0 – 9999 *	ALM
STANDBY UNIT ON	2 Sec	2 sec / 0 – 9999 *	ALM
HUMIDIFIER PROBLEM	2 Sec	2 sec / 0 – 9999 *	ALM
NO CONNECTION w/Unit1	Internal Calc.	-	WRN
UNIT X DISCONNECTED	Internal Calc.	-	WRN
LOSS OF POWER	0 Sec	No	ALM
CUSTOMER INPUT 1	2 Sec	2 sec / 0 – 9999 *	ALM
CUSTOMER INPUT 2	2 Sec	2 sec / 0 – 9999 *	ALM
CUSTOMER INPUT 3	2 Sec	2 sec / 0 – 9999 *	ALM
CUSTOMER INPUT 4	2 Sec	2 sec / 0 – 9999 *	ALM
CALL SERVICE	2 Sec	2 sec / 0 – 9999 *	MSG
HIGH TEMPERATURE	2 Sec	2 sec / 0 – 9999 *	MSG
LOSS OF AIR BLOWER 1	2 Sec	2 sec / 0 – 9999 *	ALM
REHEAT LOCKOUT	2 Sec	2 sec / 0 – 9999 *	WRN
HUMIDIFIER LOCKOUT	2 Sec	2 sec / 0 – 9999 *	WRN
FC LOCKOUT	2 Sec	2 sec / 0 – 9999 *	WRN
COMPRESSOR(S) LOCKOUT	2 Sec	2 sec / 0 – 9999 *	WRN
COMP 1 SHORT CYCLE	0 Sec	0 - 9999	MSG
COMP 2 SHORT CYCLE	0 Sec	0 - 9999	MSG

3.7 POSSIBLE EVENT NOTIFICATIONS

Table 9 lists alarms and warnings that may occur in a cooling unit. When any of these occur, they will appear on the Liebert iCOM Status menu and will be recorded in the Liebert iCOM Event log.

Table 9 Event notifications—large or small display

Event	Type
COMP 1 HRS EXCEEDED	WRN
COMP 2 HRS EXCEEDED	WRN
EL HEAT1 HRS EXCEEDED	WRN
EL HEAT2 HRS EXCEEDED	WRN
EL HEAT3 HRS EXCEEDED	WRN
FC HRS EXCEEDED	WRN
GENERAL ALARM	ALM
GLYCOL TEMP SENSOR	WRN
HIGH CW TEMP	WRN
HUM HRS EXCEEDED	WRN
HUMIDIFIER PROBLEM	—
HW/HG HRS EXCEEDED	WRN
LOSS OF CW FLOW	WRN
NETWORK FAILURE	WRN
ON-OFF KEY DISABLED	WRN
POWER ON	MSG
POWER OFF	MSG
ROOM SENSOR FAILURE	ALM
UNIT DISABLED	MSG
UNIT HRS EXCEEDED	WRN
UNIT ON	MSG
UNIT OFF	MSG
UNIT DISABLED	MSG
UNIT SHUTDOWN	MSG
UNIT SYNCHRONIZATION	MSG
SENSOR A FAILURE	WRN
SLEEP MODE	MSG
STANDBY MODE	MSG
SUPPLY SENSOR FAILURE	WRN

3.8 Next Maintenance Calculation

The next maintenance calculation, as well as the included diagnostics feature, will help run the cooling unit optimally to ensure minimum component stress resulting in maximum reliability. The diagnostics will help the service engineer evaluate the unit's operation, reading back operational data since the last maintenance.

3.8.1 Calculation of Next Maintenance and Diagnostics

The following components are included in the calculation, each one individually:

- Fan(s)
- Compressor 1
- Compressor 2
- Electric Heaters
- Humidifier

For each individual component, the next maintenance will be calculated from the following parameters:

- Standard service interval (1, 2 or 4 times a year) (to be set)
- Working hours (counted)
- Number of starts (counted)
- Average running time (calculated)
- Optimum number of starts per hour (to be set)
- Maximum number of starts per hour (to be set)
- Maximum bonus to enlarge time to next maintenance (to be set)
- Maximum penalty to reduce time to next maintenance (to be set)

Calculating Unit Wellness

Liebert iCOM keeps tabs on the condition of a cooling unit, determining its wellness and projecting when service will be needed, for the entire unit as well as for individual components. This assists in scheduling maintenance calls and helps pinpoint components likely to require service.

Liebert iCOM displays a graphic for needed maintenance. It begins with the standard maintenance interval—12 months, six months or three months—and adjusts that based on its calculation of components' wellness.

To calculate wellness, Liebert iCOM keeps a running total of component working hours and the number of times it has been started. Liebert iCOM relates that data to the optimum/maximum starts per hour. Accordingly, Liebert iCOM will increase or decrease the time before the next service call will be needed.

The more frequently a component starts, the sooner it is likely to need maintenance. If, for example, a unit's fan runs continuously, but its compressor starts and stops often, Liebert iCOM records that and calls for maintenance based on the compressor's wellness factor.

Alarms and warnings, such as clogged filters or high or low pressure, reduce the time till the next maintenance to zero. If the alarm is cleared and reset, Liebert iCOM recalculates wellness. It begins with the pre-alarm maintenance time and factors in the alarm.

Parameters for Next Maintenance Calculation

General Maintenance Settings

- **Maintenance Frequency**—can be set as one to 12 months or to zero, which disables maintenance calculation
- **Max. Bonus**—increases the time to next maintenance with the set value, if all components run optimally (number of starts, average running time)
- **Max. Penalty value**—decreases the time to next maintenance with the set value, if some components run in non-optimum way (number of starts, average running time)
- **Last Maintenance**—date can be set from service-engineer; informational
- **Service-Engineer**—name of the service engineer; editable
- **Reset**—puts all counters of all components, such as (motor, compressors, heaters and humidifier), at zero and starts a new maintenance calculation (reset to be done after maintenance)

Fans / Heaters / Humidifier Settings and Diagnostics

- Number of starts and Working hours are counted separately since the last maintenance. Total working hours can be read in the standard working hours window (customer window).
- Average Working Hours is the calculation, resulting from starts and working hours.
- Starts per Day Optimum is the number of starts considered as optimum.
- Starts per Day Worst is the number of starts considered as hunting (worst case).
- Number of Alarms counts the alarms, happened between two service intervals.
- Actual Bonus is calculated from number of starts and average working time. Can be positive (bonus) or negative (penalty). This value influences the time remaining to the next maintenance.

Compressor 1 / 2 Settings and Diagnostics

- Number of starts and Working hours are individually counted since the last maintenance. Total working hours can be read in the standard working hours window (customer window).
- Average Working Hours is the calculation, resulting from starts and working hours.
- Starts per Day Optimum is the number of starts considered as optimum.
- Starts per Day Worst is the number of starts considered as hunting (worst case).
- Number of HP Alarms counts the high-pressure alarms, happened between 2 service intervals.
- Number of LP Alarms counts the low-pressure alarms, happened between 2 service intervals.
- Number of TH Alarms counts the thermal protection alarms, happened between 2 service intervals.
- Actual Bonus is calculated from number of starts and average working time. Can be positive (bonus) or negative (penalty). This value influences the time remaining to the next maintenance.

4.0 TEAMWORK

Unit-2-Unit (U2U) Communications via a private network will allow the following functions to be placed into operation when the requirement exists. The user must install the correct hardware (see **5.0 - Installing a Liebert iCOM Unit-to-Unit Network**) and properly program the units for the selected functionality.

The Liebert iCOM network can perform the following functions:

The **Teamwork Mode** functions allow for multiple stages of cooling/heating and humidification/dehumidification. Teamwork Mode can be used to prevent environmental units from “fighting,” where one environmental unit might be cooling while another unit is heating.

The **Standby (Lead/Lag)** function allows one or more units to be set as “Running” and “Standby” for activation in case of an alarm. This function also allows the units to be programmed in a rotation to help ensure “Standby” unit operation.

The **Cascade Operation** function allows additional units to be staged-on based on the temperature or humidity requirement.

4.1 Teamwork Modes

Groups of cooling units connected to a network can be set up to work together in any of three teamwork modes: No Teamwork, Teamwork Mode 1 and Teamwork Mode 2. All Liebert iCOM-controlled cooling units on a network must be set to run in the same Teamwork mode.

4.1.1 Application of Teamwork Modes

- **No Teamwork:** Multiple zones in one room.
- **Teamwork Mode 1:** Balanced load (small groups of units inside the same environment)
- **Teamwork Mode 2:** Unbalanced load (large rooms, not all units will have the same load) (work well for most applications)

All units in a network will run in the same Teamwork Mode.

4.1.2 No Teamwork

All cooling units work independently, responding to their own sensors.

Standby function and unit rotation are possible, but cascading is not (see **Standby and Cascade on page 40**). AutoSet will not adjust the proportional band in Teamwork mode No.

4.1.3 Teamwork Mode 1

Teamwork Mode 1 works best in small rooms with balanced heat loads. This mode does not operate based on the most demanding unit on the network. The return temperature and humidity sensor readings of all units in operation (fan on) are averaged by the master unit, Unit #1, and used for control. The master unit will send the performance requests unitwise according to unit numbers, rotated by one unit every 24 hours.

In this teamwork mode most of the parameters are shared; if set in any one of the units, all other units will follow with the same settings. AutoSet will adjust the proportional band in Teamwork Mode 1, see **3.2.1 - Temperature Proportional Band**.

The master unit evenly divides the system proportional band among the number of available units. Each unit will receive instruction on how to operate from the master unit based on how far the system deviates from the setpoints.

The number of available units is calculated like:

- In non-standby configuration: all units with fan on
- In typical standby function (no cascade): all units with fan on
- In cascade mode: all units that could operate (no alarm, which forces the unit to switch off, unit not switched off, etc.)



NOTE

1. Proportional actuators (chilled water valve, free-cooling actuator) are driven in parallel in all units.
2. Changeover to second cooling source, low limit during dehumidification and low supply limit control air local functions, managed from each unit independently.

Figure 23 shows how two cooling units work together in Teamwork Mode 1. Since Unit 1 and Unit 2 are available to operate, the master unit, Unit 1, averages the temperature and humidity sensor readings from each unit.

The master unit determines that a 60% call for cooling is required for the system. Since there are two available cooling units, each unit makes up half of the system proportional band; Unit 1 handles 0-50% system call for cooling and Unit 2 handles 51-100%. For every 1% system call for cooling, each unit provides 2% of its total cooling capacity.

The 60% system call for cooling exceeds the 50% Unit 1 can provide, so Unit 1 operates at full capacity. The remaining 10% system call for cooling ($60\% - 50\% = 10\%$) is handled by Unit 2. Unit 2 responds by operating at 20% cooling capacity ($50\% \div 10\% = 20\%$).

Figure 23 Teamwork Mode 1 with two cooling units

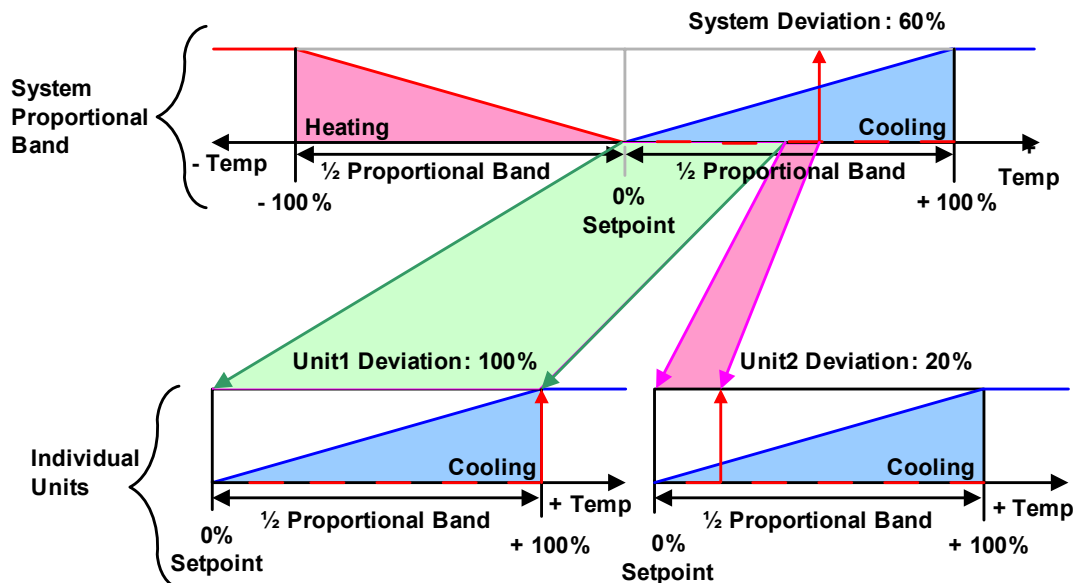

4.1.4 Teamwork Mode 2

Teamwork Mode 2 is designed to prevent units within a group from working against each other or “fighting.” It is best applied in large rooms with unbalanced heat loads. In Teamwork Mode 2, all parameters are shared equal to Mode 1, and Unit #1 averages all of the available unit sensor readings on the network to define whether there is a cooling, heating, dehumidification or humidification request.

If there is a cooling request, all units are released to start cooling resources according to their own temperature readings; heating is disabled for all units – and vice versa. Same for humidity control.

If the network average would ask for 0% proportional band, the most demanding request (highest or lowest temperature of all units, highest or lowest humidity of all units) would be used to define the operation to be performed.

Teamwork Mode 2 does not rotate – unevenly distributed working hours to be expected. Autoset will not adjust the proportional band.



NOTE

In Teamwork Mode 2, all units must have the same setpoints. The units' proportional band, deadband and related settings may differ.

4.1.5 Standby – Rotation

Typical Standby (Lead/Lag) Function

This function can be performed in any teamwork mode, including NO.

One or more units can be defined to be Standby; the normal status of standby units is Standby Off (fan off).

In case one regular unit has an alarm that is defined (to be defined in the alarm configuration), to switch on a standby unit, the faulty unit will switch off and the standby unit will switch on.

If the next unit has an alarm, the next standby unit will be started. If no more standby units are available, the unit with a non-critical alarm that permits unit operation will be switched on again (water detection, fan alarm, fire alarm etc. will not permit unit restarting).

The standby function can be rotated daily (setting the time), weekly (setting the day of the week and time) or monthly (setting the first weekday of the month and time).

The rotation is performed with a selectable number of units: if 1 is selected, to standby rotates from 1-2 to 2-3 in a 4 units configuration with two standby units, and rotates from 1-2 to 3-4 in the same configuration, when the rotation parameter is set to 2.



NOTE

Before entering standby mode, units will operate the fan only for 3 minutes to cool the electrical heaters, remove steam from the unit, etc.

Standby and Cascade

Cascade is possible in Teamwork Mode 1 only.

Standby units will start if an alarm occurs in one of the operational units. If the standby units are cascaded, they will also start and work with the regular operational units if the temperature or humidity cannot be controlled by the operational units; before a high or low temperature / humidity condition occurs. Cascaded units are switched off again as soon as the temperature / humidity returns back to normal.

The master unit defines its proportional band according to the number of available units (see **4.1.3 - Teamwork Mode 1**).

When a standby unit receives a request for full heating or cooling from the master unit (see **3.2.1 - Temperature Proportional Band**), it will respond to the request after its control delay.



NOTE

Cascaded units are not included in the calculation of the average temperature / humidity.

5.0 INSTALLING A LIEBERT iCOM UNIT-TO-UNIT NETWORK

Connecting multiple Liebert iCOM-controlled cooling units in an Ethernet Unit-to-Unit (U2U) network enables the units to work together to achieve efficient cooling and humidity control of the conditioned space. Networking enables setting up the cooling units to exchange data for various modes of operation:

- Teamwork
- Lead/Lag-Standby
- Rotation
- Cascade

However the cooling units are set up, a large display may be used to control and view the operational status of individual units or of the entire system.



NOTE

The maximum number of cooling units that may be interconnected is 32.

5.1 Placement of Cooling Units

Refer to the cooling unit product manuals for details on installation. Also consider these factors when planning for installation of cooling units with Liebert iCOM controls:

- heat load in the conditioned space
- cooling air distribution
- number of operating units versus number of standby cooling units
- location of the network switch—An Ethernet cable cannot exceed 328 feet (100m)

5.2 U2U Hardware: Cables and Network Switch

Plan wiring runs for U2U communication when designing the layout of your conditioned space. In addition to general good wiring practices, take into account:

- Ethernet CAT5 or greater cable is required for interconnecting the units.
- Maximum distance must not exceed 328 feet (100m).
- A device to boost the Ethernet signal may be used to exceed the 328 feet (100m) length limitation.
- Ethernet network should be private—set up only for management and control of the cooling units.
- Keep control and communication cables away from power cables to prevent electromagnetic interference.
- Do not bend cables to less than four times the diameter of the cable.
- Do not deform cables when securing in bundles or when hanging them.
- Keep cables away from devices that can introduce noise into them, such as machines, fluorescent lights, and electronics.
- Avoid stretching Ethernet cables—tension when pulling cables should not exceed 25 pounds (11kg).
- Do not secure Ethernet cables with any method that might damage them; use approved hangers, such as telephone wire/RG-6 coaxial wire hangers, available at most hardware stores.

Minimum Network Switch Requirements

- IEEE 802.3; IEEE 802.3u
- 10/100 Mbps speed
- Multiple 10/100 RJ-45 ports—one shared; RJ-45 Uplink port

The Liebert vNSA™ is an approved powered network switch designed to support Liebert iCOM U2U networks. See **Liebert vNSA on page 46** for details.

5.3 Wiring for Unit-to-Unit Communications—U2U

Cooling units come from the factory-wired for stand-alone operation.

Liebert iCOM U2U Ethernet Network

The Liebert iCOM U2U network must be isolated from other network traffic. The network switch(es) that connect Liebert iCOM controls need to be dedicated to supporting only Liebert iCOM communication. The U2U network cannot be connected to the building or IT network. If network communication is ever lost (failed network switch, etc.), all Liebert iCOM-controlled cooling units will continue to operate as independent units.

The Liebert iCOM control can support up to 64 nodes on one network. An input/output board, large display, and large wall-mount display are each considered one node. Of the 64 nodes that may be connected, no more than 32 may be input/output boards (32 cooling units). A small display is not considered a node. Small displays connect directly to input/output boards that do not have large displays attached to them. The following table illustrates how a network can be configured.

Table 10 Sample Liebert iCOM network configurations

Sample Configuration	Input/Output Boards	Large Displays	Small Displays	Wall Mount Large Displays	Private Switch Required
1	2	0	2	0	No
2	2	0	2	1	Yes
3	3	0	3	0	Yes
4	2	1	1	0	Yes
5	8	4	4	1	Yes
6	32	32	0	0	Yes
7	32	27	5	5	Yes
8	32	0	32	32	Yes

Network communication can be configured during system startup by a Liebert-trained technician. For technical issues contact:

Liebert Technical Service
 1050 Dearborn Drive
 Columbus, Ohio 43235
 Telephone: 1-800-LIEBSRV (1-800-543-2778)
 E-Mail: technicalservice@emersonnetworkpower.com

5.3.1 Wiring a Liebert iCOM U2U Network

Small Displays

Two cooling units, each with a small display: To network two cooling units, each with a small display, connect a crossover CAT5 cable between the P64 connectors on each cooling unit's Liebert iCOM input/output board. A network switch is not needed (see **Figure 24**).

Figure 24 Connecting two cooling units, each with a small display using a crossover Ethernet cable

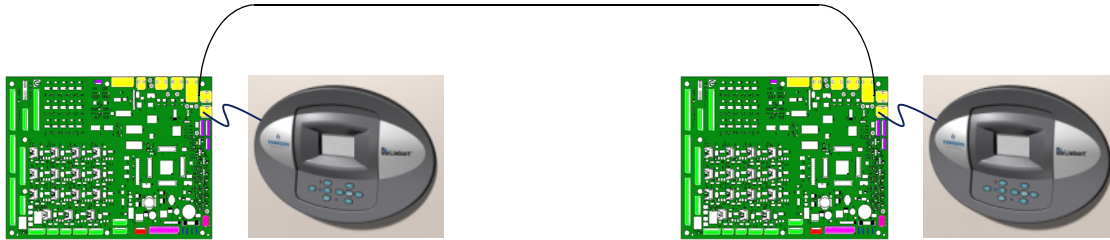

Three or more units with small displays: To network three or more cooling units, each equipped with a small display, connect a straight-through CAT5 Ethernet cable from the P64 connector on each cooling unit's Liebert iCOM input/output board to a common network switch (see **Figure 26**).

Large Displays

A network switch is required to enable Ethernet communication on one or more cooling units with large displays. Each cooling unit with a large display requires two straight-through Ethernet cables from a network switch. One cable connects to port P64 on the Liebert iCOM input/output board and the other straight-through cable connects to the female-female coupler provided with the unit. Connect the red crossover cable, which is provided with the cooling unit, between the coupler and the P64 port on the back of the large display (see **Figure 28**).



NOTE

Only cooling units with large displays are supplied with a female-female coupler inside the unit from the factory.

Wall-Mount Large Display

Only large displays can be used for remotely monitoring and controlling cooling units connected on the same network. Each wall-mount large display requires 120V input power; Liebert provides an AC adapter wall plug. A straight-through Ethernet cable must be connected between the network switch and the P64 port on the back of the display. This will enable control and monitoring capabilities to any cooling unit connected to the network. See **6.0 - Mounting a Large Display on a Wall** for mounting details and **Figure 31** for wall-mount dimensions.

Combining Large and Small Displays on a U2U Network

Setting up a network of cooling units equipped with large and small displays requires a network switch. The controls are to be connected to the switch as described above.

Figure 25 Wiring a small display for stand-alone operation

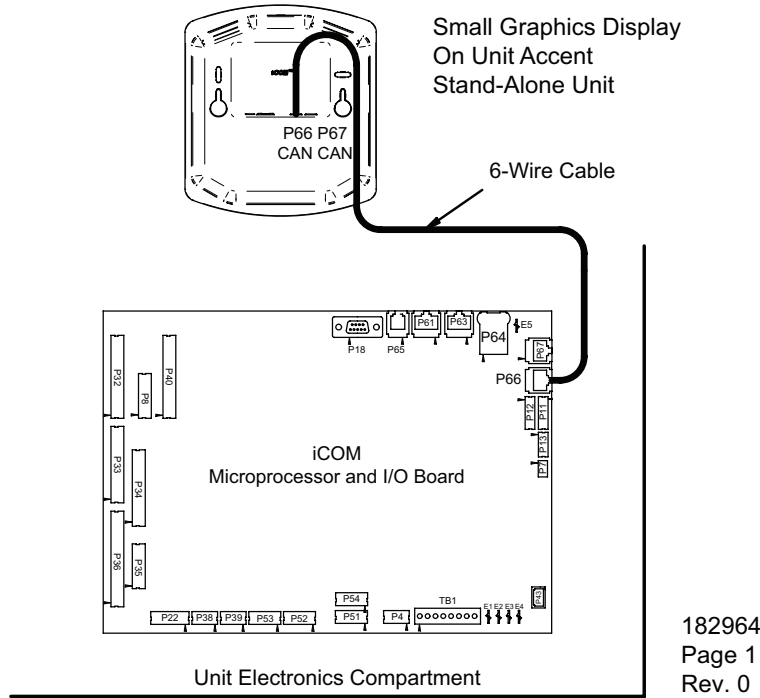

Figure 26 Wiring a small display for U2U network operation

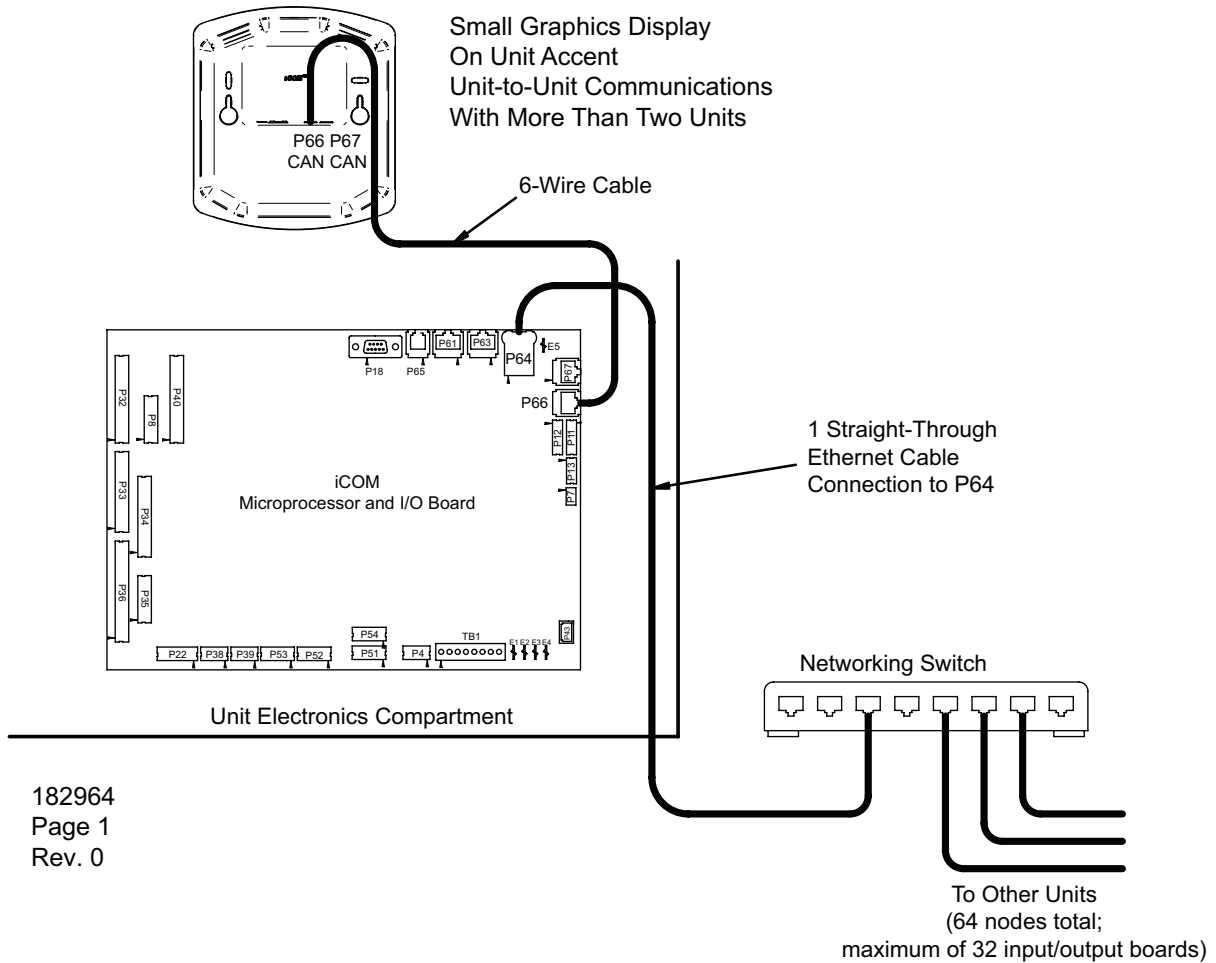

Figure 27 Wiring a large display for stand-alone operation

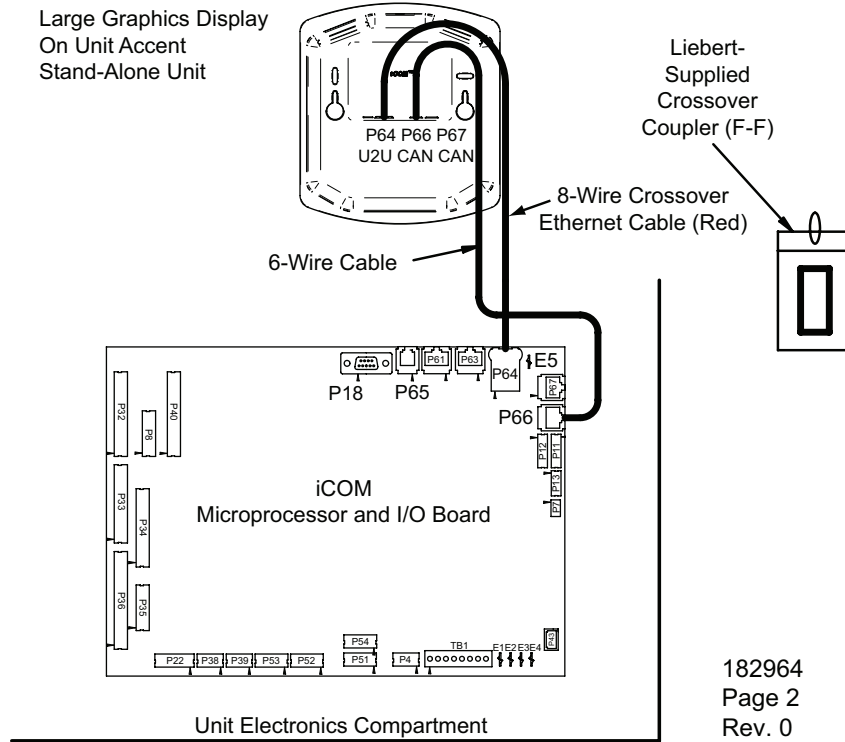

Figure 28 Wiring a large display for U2U network operation

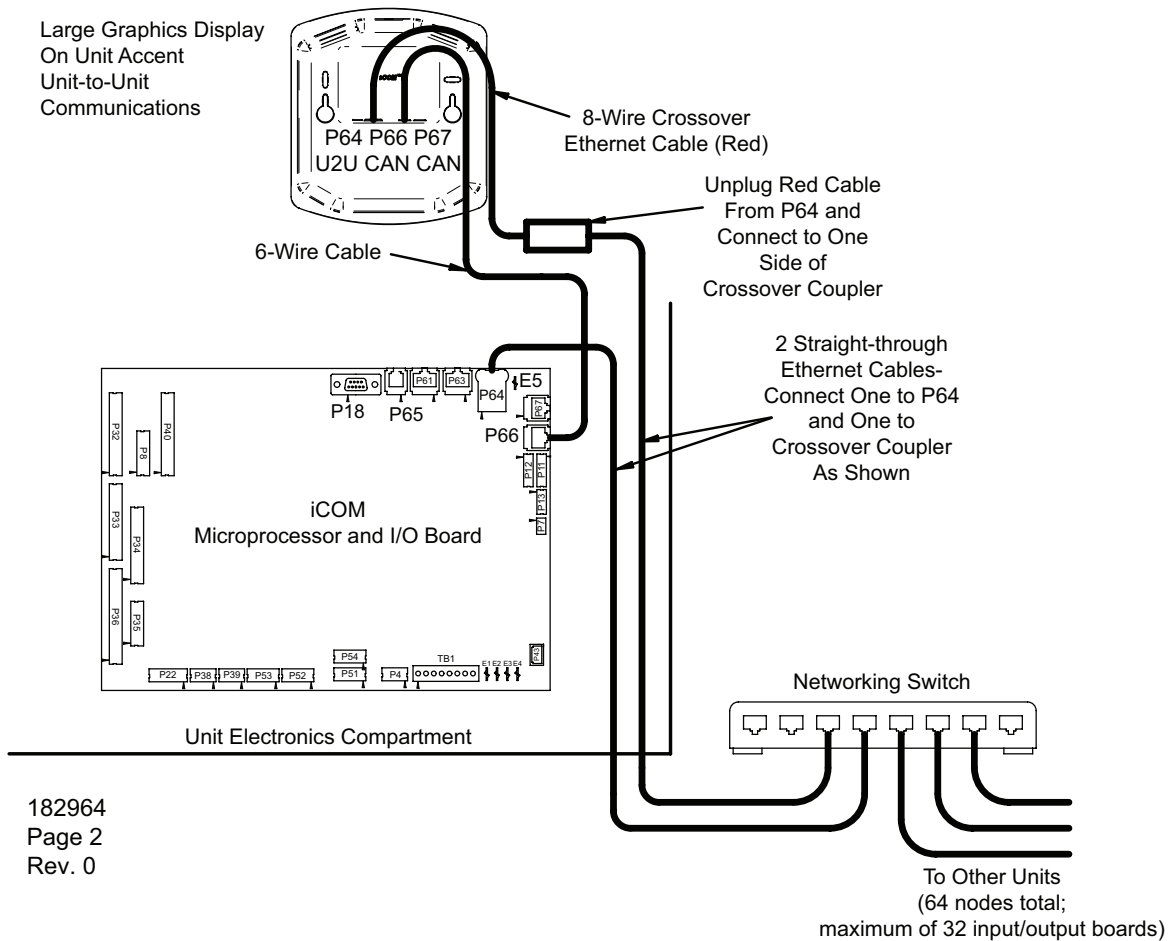
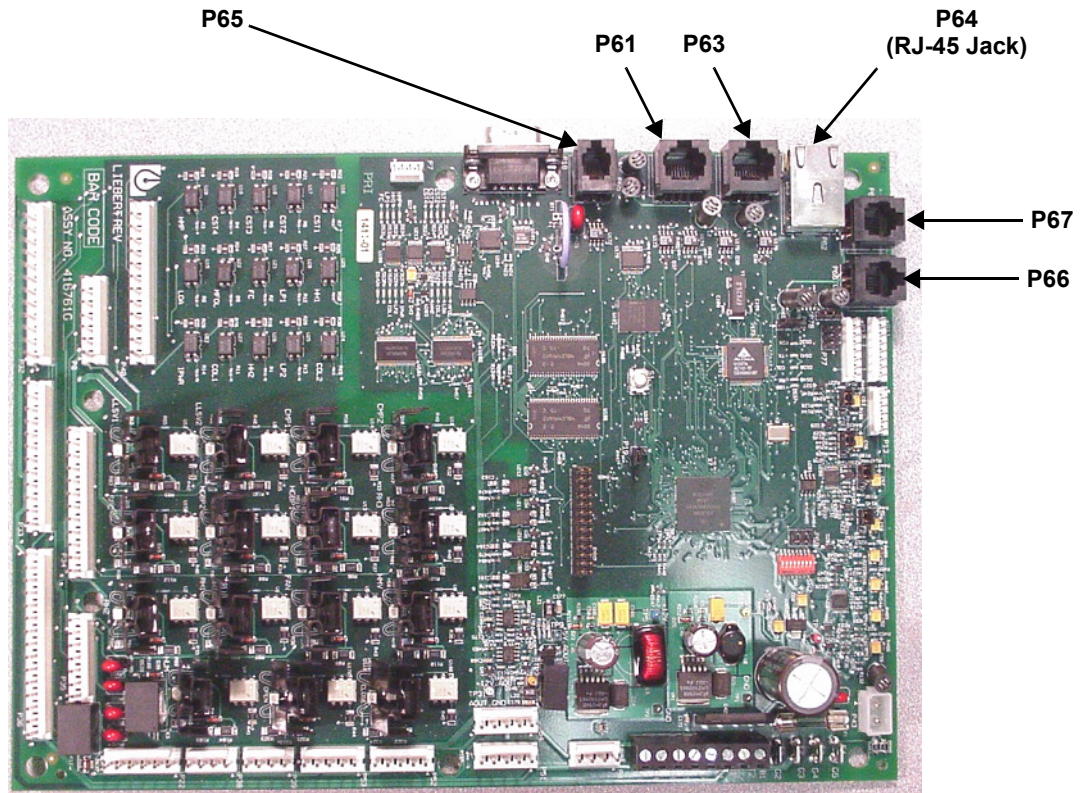

Figure 29 Liebert iCOM input-output control board



Liebert vNSA

The Liebert vNSA is designed to connect multiple Liebert iCOM control devices. The Liebert vNSA contains either one or two powered industrial rail switches. An optional remote large display can be attached to the front door as well. All models have a power supply that requires connection to a single phase 120V or 240VAC power source. The enclosure features a key lock for security.

The Liebert vNSA supports autonegotiation, autopolarity and autocrossing, allowing for the use of standard network cables for connection to each port, rather than special crossover cables. The switch detects and makes adjustments for the network's speed and transmission mode, polarity and transmit-and-receive pins. See the Liebert vNSA user manual, SL-18840, for more details.

The number of ports available for connecting Liebert iCOM control devices varies by model as shown in **Table 11**. Models with a remote large display attached to the front door utilize one of the available Ethernet ports in the Liebert vNSA. Models with two switches utilize two ports to connect the switches.

Table 11 Ports available for connecting Liebert iCOM control devices

Model	Liebert vNSA With Remote Large Display	Total Number of Ports	Number of Ports Used to Connect Remote Large Display	Number of Ports Used to Interconnect Switches	Number of Ports Available to Connect Liebert iCOM Control Devices
Liebert vNSA8-Liebert iCOM	Yes	8	1	-	7
Liebert vNSA16-Liebert iCOM		16	1	2	13
Liebert vNSA8	No	8	-	-	8
Liebert vNSA16		16	-	2	14

Figure 30 Liebert vNSA with optional remote large display

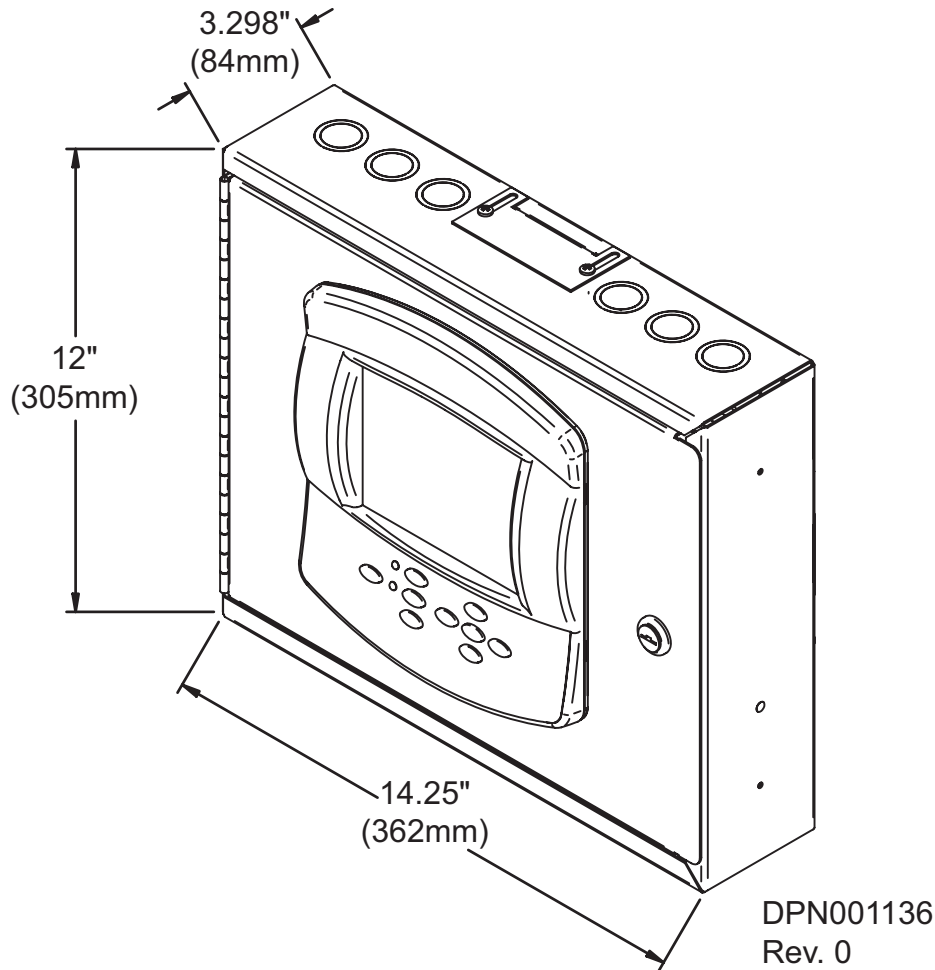

5.4 External Communications—Building Management Systems, Liebert SiteScan[®]

Liebert iCOM is capable of communicating with external monitoring systems, such as Building Management Systems (BMS), Network Monitoring Systems (NMS), Liebert's SiteScan[®] Web system and others.

Each Liebert iCOM-controlled cooling unit is equipped with Liebert IntelliSlot plug-in slots for use with optional communication cards:

- Ethernet Web/SNMP Card
- RS-485 Modbus Card

The hot-swappable plug-in cards provide interfaces supporting open protocols, including Modbus, HTTP (Web) and SNMP. See the Liebert Web site for the latest supported protocols, Modbus reference information and SNMP MIB's.

An alternative, limited method of communicating with an existing Liebert SiteScan Web monitoring system is via twisted-pair cables connected to terminals 77 and 78 on the cooling unit terminal strip. To use this method, the Liebert IntelliSlot power supply connection to P65 on the iCOM I/O board must be unplugged, and the factory-supplied 77-78 cable must be connected to P65 (follow Liebert SiteScan instructions for further connections). The appropriate Liebert iCOM control parameters will also need to be configured to utilize the terminals.



NOTE

Liebert SiteScan will be limited to legacy parameters when communicating via terminals 77 and 78.

6.0 MOUNTING A LARGE DISPLAY ON A WALL

6.0.1 Location Considerations

Consider these factors before beginning work on a wall-mount installation:

- Power supply—Liebert iCOM requires an electricity source. A factory-supplied 120VAC transformer connects to the back of the large display.
- Availability of communication cable—CAT5 Ethernet cable connection on the back of the large display
- Distance from network switch—maximum of 328 feet (100m)
- Accessible location for personnel

Necessary Mounting Items

- #10 pan head type screws or bolts—quantity 2, field-supplied
- Wall anchors sized for #10 pan head type screws or bolts—quantity 2, field-supplied, if mounting on drywall or similar surface

Mounting Instructions

1. See **Figure 31** for dimensions and mounting arrangements. Mark the wall where screws or bolts will be inserted to support the large display.
Either of two mounting methods may be used:
 - a. Secure the back of the large display to the wall by inserting screws or bolts through the elliptical slots (recommended mounting method), or
 - b. Insert screws in the wall and use the keyhole-shaped holes on the back of the housing
2. Route the factory-supplied power supply cable and field-supplied CAT5 Ethernet cable through the wall to the mounting location for connection to the rear of the Liebert iCOM wall-mount display (see **Figure 31**).
3. Remove the back of the display by prying it away from the front half of the housing using the coin slots along the seam.
4. Insert the power and Ethernet cables through slots in the rear of the display (slots are marked). Leave adequate slack for connections and mounting.
To relieve strain on the connections to the display circuit board:
 - a. Use the strain-relief slots above the connections on the upper part of the recessed area to hold the cables.
 - b. Use a twist tie to secure the cables to the small bridge on the back of the display.
5. Position the display and use either of the following methods to attach the display to the wall:
 - a. **Elliptical Slot Mounting:** Insert the #10 pan head screws or bolts through the elliptical slots and screw into the wall or wall anchors. Tighten firmly.
OR
 - b. **Keyhole Slot Mounting:** Insert the #10 pan head screws or bolts into the wall, leaving space between the screw head and wall to permit hanging the display.
6. Connect the power and Ethernet cables to the display circuit board (the board is marked).
7. Attach the front of the display to the mounted rear panel of the assembly—unit snaps together.

Figure 31 Liebert iCOM display dimensions

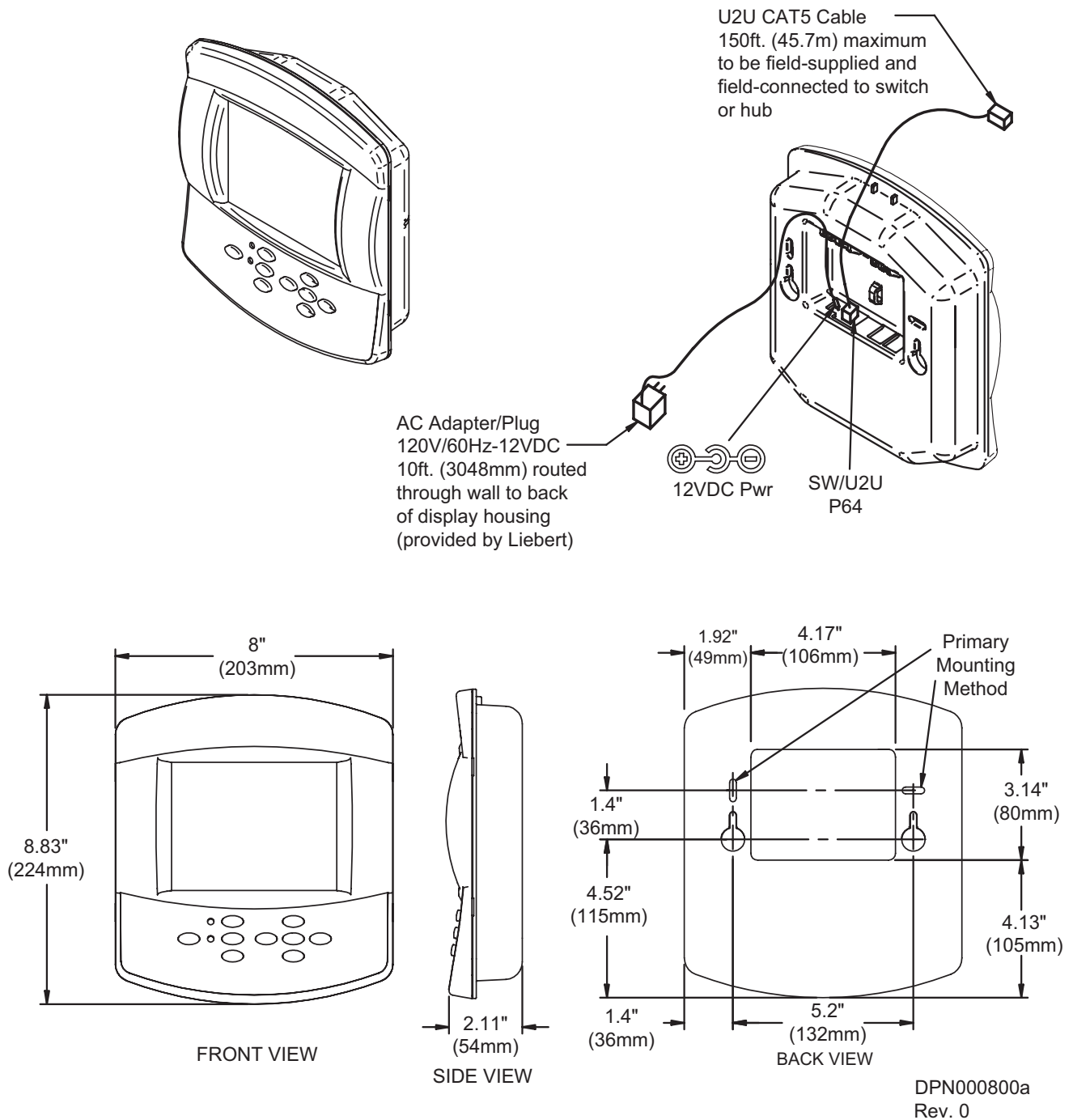

7.0 USER MENU PARAMETERS

User menus report general cooling unit operations and status. The password for the user menu is 1490.

The iCOM control firmware is being updated constantly. As a result, the User menu parameter tables in this manual may be slightly different than what is shown on your cooling unit's display. Please check www.liebert.com for the latest iCOM User manual updates.

°C / °F
% RH
SET

Table 12 Setpoints parameters

Function		Read/ Write	Range Imperial (metric)	Default Setting
Large Display	Small Display			
Page 1 of 1				
Password	PASSWORD	W	-	-
Temperature Setpoint	TEMP SET	W	41-104°F (5-40°C)	73°F (23°C)
Humidity Setpoint	HUM SET	W	20-80%	50%
Humidity Control Type	HUM CTRL	W	Relative, Compensated, Predictive	Predictive
Supply Limit	SUP LIM	W	Enabled, Disabled	Disabled
Supply Limit Temp Value	SUP TEMP	W	41-77°F (5-25°C)	41°F (5°C)

Spare Part List—Large Display Only

Displays the various Liebert part numbers for all parts in the cooling unit to simplify ordering replacement parts.

Table 13 Spare part list parameters—large display only

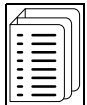

Function		Read/ Write	Range Imperial (metric)	Default Setting
Large Display	Small Display			
Page 1 of 1				
List of parts	N/A	R	-	-

Table 14 Event log parameters

EVENT
LOG

Function		Read/ Write	Range Imperial (metric)	Default Setting
Large Display	Small Display			
Page 1 of 1				
Last 400 events	Last 400 events	R	-	-

**Table 15 Graphics parameters**

Function		Read/ Write	Range Imperial (metric)	Default Setting
Large Display	Small Display			
Page 1 of 1				
System temperature time scale	N/A	W	8,32 min; 1,12,24 hours, 2,4,8,16 days	24 hours
System temperature graph height	N/A	W	±5-36°F (±3-20°C)	11°F (6°C)
System humidity time scale	N/A	W	8,32 min; 1,12,24 hours, 2,4,8,16 days	24 hours
System humidity graph height	N/A	W	±10-30%	25%
Unit temperature time scale	UNIT TEMPERATURE TIME SCALE	W	8,32 min; 1,12,24 hours, 2,4,8,16 days	24 hours
Unit temperature graph height	UNIT TEMPERATURE GRAPH HEIGHT	W	±5-36°F (±3-20°C)	11°F (6°C)
Unit humidity time scale	UNIT HUMIDITY TIME SCALE	W	8,32 min; 1,12,24 hours, 2,4,8,16 days	24 hours
Unit humidity graph height	UNIT HUMIDITY GRAPH HEIGHT	W	±10-30%	25%

**Table 16 View network parameters—large display only***

Function		Read/ Write	Range Imperial (metric)	Default Setting
Large Display	Small Display			
Page 1 of 1				
Status Unit 1—32	N/A	R	-	-

* Permits viewing all units connected in a network. Viewable on a large display only.

**Table 17 Set alarms parameters**

Function		Read/ Write	Range Imperial (metric)	Default Setting
Large Display	Small Display			
Page 1 of 1				
Password	PASSWORD	W	-	-
Return Sensor Alarms	RTN SNSR	W	Enabled, Disabled	Enabled
High Return Temperature	HI TEMP	W	34-210°F (1-99°C)	80°F (27°C)
Low Return Temperature	LO TEMP	W	34-210°F (1-99°C)	65°F (18°C)
High Return Humidity	HI HUM	W	1-99%	60%
Low Return Humidity	LOW HUM	W	1-99%	40%
Sensor A Alarms	SENSOR A	W	Enabled, Disabled	Disabled
High Temperature Sensor A	HI TEMP A	W	34-210°F (1-99°C)	90°F (32°C)
Low Temperature Sensor A	LO TEMP A	W	34-210°F (1-99°C)	55°F (13°C)
High Humidity Sensor A	HI HUM A	W	1-99%	70%
Low Humidity Sensor A	LO HUM A	W	1-99%	30%



Table 18 Sensor data parameters

Function		Read/ Write	Range Imperial (metric)	Default Setting
Large Display	Small Display			
Page 1 of 2				
Actual Temperature Setpoint	TEMP SET	R	41-104°F (5-40°C)	-
Actual Humidity Setpoint	HUM SET	R	20-80%	-
Optional Sensor A Temperature	TEMP A	R	32-122°F (0-50°C)	-
Optional Sensor A Humidity	HUM A	R	20-80%	-
Optional Sensor B Temperature	TEMP B	R	32-122°F (0-50°C)	-
Optional Sensor B Humidity	HUM B	R	20-80%	-
Optional Sensor C Temperature	TEMP C	R	32-122°F (0-50°C)	-
Optional Sensor C Humidity	HUM C	R	20-80%	-
Freecooling Fluid Temperature	FC TEMP	R	4-113°F (-15-45°C)	-
DigiScroll 1 Temperature	DS1 TEMP	R	84-313°F (29-156°C)	-
DigiScroll 2 Temperature	DS2 TEMP	R	84-313°F (29-156°C)	-
Freecooling Status	FC STATE	R	Off, Start, On	-
Page 2 of 2				
Daily High Temperature	HI TEMP	R	32-122°F (0-50°C)	-
Daily Low Temperature	LO TEMP	R	32-122°F (0-50°C)	-
Daily High Humidity	HI HUMI	R	20-80%	-
Daily Low Humidity	LO HUMI	R	20-80%	-

Active Alarms

Permits viewing all current, active alarms.



Table 19 Active alarms parameters

Function		Read/ Write	Range Imperial (metric)	Default Setting
Large Display	Small Display			
Page 1 of 1				
Active Alarms	ACTIVE ALARMS	R	-	-



Table 20 Display setup parameters

Function		Read/ Write	Range Imperial (metric)	Default Setting
Large Display	Small Display			
Page 1 of 1				
Language	LANGUAGE	W	English, ...	English
Date	YEAR/MONTH/DAY	W	-	-
Time	HOUR/MINUTE/SECOND	W	hh/mm/ss	-
Temperature Indication	TEMP F/C	W	°C, °F	°C
Display Contrast	CONTRAST	W	0-100%	50%
Buzzer Frequency	BUZ FREQ / BUZ TEST	W	0-100%	50%
Backlite Off After x Hours	BACKLITE	W	5min, 10min, 30min, 1h, 12h	5 min
Screen	SCREEN	W	Graphical, Simple	Graphical
Display Shows	SHOWS	W	Set, Act, Set+Act	Set+Act
Display Colors	DISPLAY	W	Normal, Inverted	Direct
Date Format	DATE	W	mm/dd/yyyy dd.mm.yyyy yyyy-mm-dd	mm/dd/yyyy



Table 21 Total run hours parameters

Function		Read/ Write	Range Imperial (metric)	Default Setting
Large Display	Small Display			
Page 1 of 1				
Actual Hours / Limit	-	-	-	-
Fan Motor(s)	MOTOR(S)	W	0-32000	-
Fan Motor(s) Limit	LIMIT	W	0-32000	0
Compressor 1	COMP1	W	0-32000	-
Compressor 1 Limit	LIMIT	W	0-32000	0
Compressor 2	COMP2	W	0-32000	-
Compressor 2 Limit	LIMIT	W	0-32000	0
Chilled Water/Free Cool	CW/FC	W	0-32000	-
Chilled Water/Free Cool Limit	LIMIT	W	0-32000	0
HotGas / HotWater	HG / HW	W	0-32000	-
HotGas / HotWater Limit	LIMIT	W	0-32000	0
Electric Heater 1	EL HEAT1	W	0-32000	-
Electric Heater 1 Limit	LIMIT	W	0-32000	0
Electric Heater 2	EL HEAT2	W	0-32000	-
Electric Heater 2 Limit	LIMIT	W	0-32000	0
Electric Heater 3	EL HEAT3	W	0-32000	-
Electric Heater 3 Limit	LIMIT	W	0-32000	0
Humidifier	HUM	W	0-32000	-
Humidifier Limit	LIMIT	W	0-32000	0
Dehumidification	DEHUM	W	0-32000	-
Dehumidification Limit	LIMIT	W	0-32000	0

**Table 22 Timer parameters—Sleep Mode**

Function		Read/ Write	Range Imperial (metric)	Default Setting
Large Display	Small Display			
Page 1 of 1				
Password	PASSWORD	W	-	-
Sleep On:	-	-	-	-
Mon	MON	W	No, Yes	No
Tue	TUE	W	No, Yes	No
Wed	WED	W	No, Yes	No
Thu	THU	W	No, Yes	No
Fri	FRI	W	No, Yes	No
Sat	SAT	W	No, Yes	No
Sun	SUN	W	No, Yes	No
Sleep Every Day (1)	-	-	-	-
From / To	START1 / START1 / STOP1 / STOP1	W	Time (hh:mm)	00:00 00:00
Sleep Every Day (2)	-	-	-	-
From / To	START2 / START2 / STOP2 / STOP2	W	Time (hh:mm)	00:00 00:00
Timer Mode	TIME MOD	W	NO, YES, AUTO	No
Timer Mode Type	TIME TYP	W	Sys off, DeadBand	Sys Off
Dead Band	DEADBAND	W	4-27°F (2-15°C)	4°F (2°C)

**Table 23 Service contacts parameters**

Function		Read/ Write	Range Imperial (metric)	Default Setting
Large Display	Small Display			
Page 1 of 1				
Address line 1	Address line 1 A+B	R	text-string	-
Address line 2	Address line 2 A+B	R	text-string	-
Address line 3	Address line 3 A+B	R	text-string	-
Address line 4	Address line 4 A+B	R	text-string	-

8.0 SERVICE MENU PARAMETERS

Service menus allow customized settings for site operations. The password for service menu parameters is **5010**.

The iCOM control firmware is being updated constantly. As a result, the Service menu parameter tables shown in this manual may be slightly different than what is shown on your cooling unit's display. Please check www.liebert.com for the latest iCOM User manual updates.

°C / °F
% RH
SET

Table 24 Setpoints parameters

Function		Read/ Write	Range Imperial (metric)	Default Setting
Large Display	Small Display			
Page 1 of 5				
Password	PASSWORD	W	-	-
Temperature Setpoint	TEMP SET	W	41-104°F (5-40°C)	73°F (23°C)
Temperature Control Type	CTRL TYP	W	Proportional, PI, PID, Intelligent	Proportional
Temperature Proportional Band	TEMP PB	W	2-54°F (1-30°C)	7°F (-14°C)
Temperature Integration Time	TEMP INT	W	0-15 min	
Temperature Derivative Time	TEMP DER	W	0-900 sec	
AutoSet Enable	AUTOSET	W	No, Yes	Yes
Temperature DeadBand	TEMP DB	W	0-36°F (0-20°C)	
Short Cycle Control	SHORT CY	W	No, Yes	Yes
Page 2 of 5				
Password	PASSWORD	W	-	-
Humidity Setpoint	HUM SET	W	20-80%	50%
Humidity Control Type	HUM CTRL	W	Relative, Compensated, Predictive	Predictive
Humidity Proportional Band	HUM PB	W	1-20%	10%
Humidity Integration Time	HUM INT	W	0-15 min	0
Humidity Deadband	HUM DB	W	0-50%	0
Dehum/Heat Low Limit 1	LO LIM 1	W	(-)9.9°F - (-)2.0°F	-
Dehum/Heat Low Limit 2	LO LIM 2	W	(-)9.9°F - (-)2.0°F	-7.0°F
Page 3 of 5				
Password	PASSWORD	W	-	-
Supply Limit	SUP LIM	W	Enabled, Disabled	Disabled
Supply Limit Temp Value	SUP TEMP	W	41-77°F (5-25°C)	41°F
DT between Room / FC Type	FC TYPE	W	No, Contact, Value	FC: Value; DX,CW: No
DT between Room Air/ FC Fluid	FC DT	W	0-36°F (-18 - 2 °C)	8°F, 5°C
Minimum CW Temp	MIN CW	W	No, Yes	FC: Yes DX,CW: No
Minimum CW Temp Value	MIN CW	W	32-68°F (0-20°C)	45°F
VSD Fanspeed	FANSPEED	W	Auto / Manual	Auto
VSD Setpoint	VSD SET	W	0-100%	60

°C / °F
% RH
SET

Table 24 Setpoints parameters

Function		Read/ Write	Range Imperial (metric)	Default Setting
Large Display	Small Display			
Page 4 of 5				
Password	PASSWORD	W	-	-
VSD Fanspeed	FANSPEED	W	Auto, Manual, Economy	Auto
VSD Setpoint STD	VSD SET	W	60 to 100%	DX =100% CW = 60%
VSD Setpoint MIN	VSD MIN	W	60 to 100%	DX =100% CW = 60%
VSD Setpoint Dehum	VSD DEH	W	60 to 100%	DX =100% CW = 60%
VSD Setpoint No Power	VSD NOP	W	60 to 100%	DX =100% CW = 60%
Page 5 of 5				
Password	PASSWORD	W	-	-
SCR Control Type	SCR TYPE	W	Tight, Standard	Tight
Start Compressor 1 At	CO1 ON	W	-150 to +100%	0%
Stop Compressor 1 At	CO1 OFF	W	-200 to +50%	-200%
Compressor 1 Stop Delay	CO1 TD	W	0-30 min	20 min
Start Compressor 2 At	CO2 ON	W	-150 to +100%	100%
Stop Compressor 2 At	CO2 OFF	W	-200 to +50%	0%
Compressor 2 Stop Delay	CO2 TD	W	0-30 min	0 min
Cycle Time	CYCLET	R	1.0 – 200.0 sec	-
SCR Factor	SCRFACT	W	1.0 to 10.0	1.0
Actual SCR Request	ACT SCR	R	0-100%	-

Unit Diary—Large Display Only

Shows all entered program changes and maintenance performed on the unit.



Table 25 Unit diary parameters

Function		Read/ Write	Range Imperial (metric)	Default Setting
Large Display	Small Display			
Page 1 of 1				
Text entered with iST (iCOM Service Tool)	N/A	R	-	-



Table 26 Standby settings / lead-lag parameters

Function		Read/ Write	Range Imperial (metric)	Default Setting
Large Display	Small Display			
Page 1 of 1				
Password	PASSWORD	W	-	-
Number of Standby Units	#STANDBY	W	0-32	0
Rotation Frequency	ROTATION	W	No, Daily, Every Mo-Tu-We-Th-Fr-Sa-Su; (Monthly) M-Mo, M-Tu, M-We, M-Th, M-Fr, M-Sa, M-Su	No
Rotate At (hour)	ROT HOUR	W	0-23	0
Rotate At (minute)	ROT MIN	W	0-59	0
Rotate By	ROT BY	W	1-8	1
Perform One Rotation	DO ROT	W	No, Yes	-
Cascade Units	CASCADE	W	No, Yes, Cooling, Cool/Heat	No
Start all Standby Units by HT	STBY HT	W	No, Yes	No

See 3.8.1 - Calculation of Next Maintenance and Diagnostics for details on these menus.



Table 27 Maintenance / wellness settings parameters

Function		Read/ Write	Range Imperial (metric)	Default Setting
Large Display	Small Display			
Basic Settings (Page 1 of 8)				
Password	PASSWORD	W	-	-
Maintenance Frequency Per Year	FREQ/YR	W	0-12 per year	1
Max Bonus	BONUS	W	0-12	0
Max Penalty	PENALTY	W	0-12	0
Last Maintenance	LAST PM	W	Date	-
Service Engineer	SERVICE	W	Name	-
Confirm PM	CONFIRM	W	No, Yes	-
Calculated Next Maintenance	NEXT PM	W	Date	-
Motor Settings (Page 2 of 8)				
Password	PASSWORD	W	-	-
Number of Starts	STARTS	W	0-32000	-
Run Hours	RUN HRS	W	0-32000	-
Average Run Time	AVG RUN	W	0-999 min	-
Starts per Day Best	BEST	W	1-240	1
Starts per Day Worst	WORST	W	1-240	24
Number of Alarms	ALARMS	W	0-32000	-
Actual Bonus	BONUS	R	0-12	-



Table 27 Maintenance / wellness settings parameters (continued)

Function		Read/ Write	Range Imperial (metric)	Default Setting
Large Display	Small Display			
Compressor1 Settings (Page 3 of 8)				
Password	PASSWORD	W	-	-
Number of Starts	STARTS	W	0-32000	-
Run Hours	RUN HRS	W	0-32000	-
Average Run Time	AVG RUN	W	0-999 min	-
Starts per Day Best	BEST	W	1-240	12
Starts per Day Worst	WORST	W	1-240	240
Number of HP Alarms	HP AL	W	0-32000	-
Number of LP Alarms	LP AL	W	0-32000	-
Number of OL Alarms	OL AL	W	0-32000	-
Number of DS HT Alarms	DS HT AL	W	0-32000	-
Actual Bonus	BONUS	R	0-12	-
Compressor2 Settings (Page 4 of 8)				
Password	PASSWORD	W	-	-
Number of Starts	STARTS	W	0-32000	-
Run Hours	RUN HRS	W	0-32000	-
Average Run Time	AVG RUN	W	0-999 min	-
Starts per Day Best	BEST	W	1-240	12
Starts per Day Worst	WORST	W	1-240	240
Number of HP Alarms	HP AL	W	0-32000	-
Number of LP Alarms	LP AL	W	0-32000	-
Number of OL Alarms	OL AL	W	0-32000	-
Number of DS HT Alarms	DS HT AL	W	0-32000	-
Actual Bonus	BONUS	R	0-12	-
EI. Heater 1 Settings (Page 5 of 8)				
Password	PASSWORD	W	-	-
Number of Starts	STARTS	W	0-32000	-
Run Hours	RUN HRS	W	0-32000	-
Average Run Time	AVG RUN	W	0-999 min	-
Starts per Day Best	BEST	W	1-240	24
Starts per Day Worst	WORST	W	1-240	240
Number of Alarms	ALARMS	W	0-32000	-
Actual Bonus	BONUS	R	0-12	-



Table 27 Maintenance / wellness settings parameters (continued)

Function		Read/ Write	Range Imperial (metric)	Default Setting
Large Display	Small Display			
EI. Heater 2 Settings (Page 6 of 8)				
Password	PASSWORD	W	-	-
Number of Starts	STARTS	W	0-32000	-
Run Hours	RUN HRS	W	0-32000	-
Average Run Time	AVG RUN	W	0-999 min	-
Starts per Day Best	BEST	W	1-240	24
Starts per Day Worst	WORST	W	1-240	240
Number of Alarms	ALARMS	W	0-32000	-
Actual Bonus	BONUS	R	0-12	-
EI. Heater 3 Settings (Page 7 of 8)				
Password	PASSWORD	W	-	-
Number of Starts	STARTS	W	0-32000	-
Run Hours	RUN HRS	W	0-32000	-
Average Run Time	AVG RUN	W	0-999 min	-
Starts per Day Best	BEST	W	1-240	24
Starts per Day Worst	WORST	W	1-240	240
Number of Alarms	ALARMS	W	0-32000	-
Actual Bonus	BONUS	R	0-12	-
Humidifier Settings (Page 8 of 8)				
Password	PASSWORD	W	-	-
Number of Starts	STARTS	W	0-32000	-
Run Hours	RUN HRS	W	0-32000	-
Average Run Time	AVG RUN	W	0-999 min	-
Starts per Day Best	BEST	W	1-240	24
Starts per Day Worst	WORST	W	1-240	240
Number of Alarms	ALARMS	W	0-32000	-
Actual Bonus	BONUS	W	0-12	-

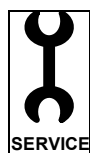

Table 28 Diagnostics / service mode parameters

Function		Read/ Write	Range Imperial (metric)	Default Setting
Large Display	Small Display			
Page 1 of 7				
Password	PASSWORD	W	-	-
HP 1 Alarm Code	HP1 CODE	W	0-999	-
HP 2 Alarm Code	HP2 CODE	W	0-999	-
HT 1 Alarm Counter	HT1 CNT	W	0-999	-
HT 2 Alarm Counter	HT2 CNT	W	0-999	-
LP 1 Alarm Code	LP 1 CODE	W	0-999	-
LP 2 Alarm Code	LP2 CODE	W	0-999	-
Page 2 of 7				
Password	PASSWORD	W	-	-
Manual Mode	MANUAL	W	No, Yes	-
Motor(s)	MOTOR(S)	W	Off, On	-
Compressor 1	COMP1	W	Off, On	-
Compressor 1	C1 MODE	W	Run, Evacuate, Charge	-
Compressor 1 Capacity	C1 CAP	W	Off, On	-
Compressor 1 Cycle Ramp	C1 CYCLE	W	0-100%	-
Compressor 1 LLSV	LLSV 1	W	Off, On	-
Compressor 2	COMP2	W	Off, On	-
Compressor 2	C2 MODE	W	Run, Evacuate, Charge	-
Compressor 2 Capacity	C2 CAP	W	Off, On	-
Compressor 2 Cycle Ramp	C2 CYCLE	W	0-100%	-
Compressor 2 LLSV	LLSV 2	W	Off, On	-
Page 3 of 7				
Password	PASSWORD	W	-	-
Electric Heat 1 (or HG/HW)	EL HEAT1	W	Off, On	-
Electric Heat 2 (or E.Heat 1)	EL HEAT2	W	Off, On	-
Electric Heat 3 (or E.Heat 2)	EL HEAT3	W	Off, On	-
BV Control	BV CTRL	W	Manual, Auto	-
LWD Value	LWD Val	R	0-100	-
Humidifier Fill	HUM FILL	W	Off, On	-
Humidifier	HUM	W	Off, On	-
Humidifier Drain	H DRAIN	W	Off, On	-
Humidifier Current	HUM.C.	R	0,00 - 99,99A	-
Status LSI	LSI	R	Off, On	-

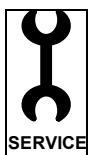

Table 28 Diagnostics / service mode parameters (continued)

Function		Read/ Write	Range Imperial (metric)	Default Setting
Large Display	Small Display			
Page 4 of 7				
Password	PASSWORD	W	-	-
Alarm Relay	ALM REL	W	Off, On	-
FC Relay	FC REL	W	Off, On	-
3P Actuator Open	3P OPEN	W	Off, On	-
3P Actuator Close	3P CLOSE	W	Off, On	-
Analog Out 1	ANALOG1	W	0-100%	-
Analog Out 2	ANALOG2	W	0-100%	-
Analog Out 3	ANALOG3	W	0-100%	-
Analog Out 4	ANALOG4	W	0-100%	-
Page 5 of 7				
Status Remote Shutdown	RSD	R	On, off	-
Status Airflow Loss	AIR LOSS	R	OK, Act	-
Status Motor Overload	MOTOR OL	R	OK, Act	-
Status Filter	FILTER	R	OK, Act	-
Status Customer Input 1	CUSTOM 1	R	OK, Act	-
Status Customer Input 2	CUSTOM 2	R	OK, Act	-
Status Customer Input 3	CUSTOM 3	R	OK, Act	-
Status Customer Input 4	CUSTOM 4	R	OK, Act	-
Status Heaters Safety	HEAT SAF	R	OK, Act	-
Page 6 of 7				
Status HP1	HP1	R	OK, Act	-
Status LP1	LP1	R	OK, Act	-
Status C1 OL	C1 OL	R	OK, Act	-
Status HP2	HP2	R	OK, Act	-
Status LP2	LP2	R	OK, Act	-
Status C2 OL	C2 OL	R	OK, Act	-

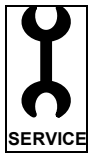

Table 28 Diagnostics / service mode parameters (continued)

Function		Read/ Write	Range Imperial (metric)	Default Setting
Large Display	Small Display			
Page 7 of 7				
Status Humidifier Problem	HUM PROB	R	OK, Act	-
Status DT1 (Outdoor/Glycol)	DT1	R	OK, Act	-
Status DT2 (Glycol/Room)	DT2	R	OK, Act	-
Status DT3 (Room/Setpoint)	DT3	R	OK, Act	-
Status Min CW	MIN CW	R	OK, Act	-
Status Condenser Failure 1	Cond 1	R	OK, Act	-
Status Condenser Failure 2	Cond 2	R	OK, Act	-



Table 29 Set alarms parameters

Function		Read/ Write	Range Imperial (metric)	Default Setting
Large Display	Small Display			
Page 1 of 7				
Password	PASSWORD	W	-	-
Return Sensor Alarms	RTN SNSR	W	Enabled, Disabled	Enabled
High Return Temperature	HI TEMP	W	34-210°F (1-99°C)	80°F (27°C)
Low Return Temperature	LO TEMP	W	34-210°F (1-99°C)	65°F (18°C)
High Return Humidity	HI HUM	W	1-99%	60%
Low Return Humidity	LOW HUM	W	1-99%	40%
Sensor A Alarms	SENSOR A	W	Enabled, Disabled	Disabled
High Temperature Sensor A	HI TEMP A	W	34-210°F (1-99°C)	90°F (32°C)
Low Temperature Sensor A	LO TEMP A	W	34-210°F (1-99°C)	55°F (13°C)
High Humidity Sensor A	HI HUM A	W	1-99%	70%
Low Humidity Sensor A	LO HUM A	W	1-99%	30%

SET
ALARMS

Table 29 Set alarms parameters (continued)

Function		Read/ Write	Range Imperial (metric)	Default Setting
Large Display	Small Display			
Page 2 of 7				
Password	PASSWORD	W	-	-
Customer Input 1	CUST IN1	W	Smoke Water Alarm C PMP Alarm Flow Alarm Stdby G Pmp Stdby Unit C-Input 1 C-Input 2 C-Input 3 C-Input 4 Rht Lockout Hum Lockout Rht+Hum Lock Comp Lockout Call Service High Temp FC Lockout Air Loss Heater Alarm Flow AL SD Flow AL LC Comp Lock PD Enable FC HTRJ VFD HTRJ TVSS	Water Alarm
Customer Input 1 active when	C1 ACT	W	Open, Closed	Closed
Customer Input 2	CUST IN2	W	Like Custom 1	Water Alarm
Customer Input 2 active when	C2 ACT	W	Open, Closed	Closed
Customer Input 3	CUST IN3	W	Like Custom 1	Water Alarm
Customer Input 3 active when	C3 ACT	W	Open, Closed	Closed
Customer Input 4	CUST IN4	W	Like Custom 1	Water Alarm
Customer Input 4 active when	C4 ACT	W	Open, Closed	Closed
WARNING ACTIVATES ALARM RELAY	WA AC AL	W	Yes, No	Yes
Reset Disabled Alarms	AL.RES.	W	Yes, No	No

SET
ALARMS**Table 30 Set alarms parameters (continued)**

Function		Read/ Write	Delay (Default)	ENABLE - DISAB (Default)	Alarm Type (Default)
Large Display	Small Display				
Page 3 of 7					
Password	PASSWORD	W	-	-	-
Main Fan Overload	FOL	W	0-9999 sec (10)	Enable, Disab (Enable)	ALM,WRN,MSG (ALM)
Loss Of Airflow	LOA	W	0-9999 sec (10)	Enable, Disab (Enable)	ALM,WRN,MSG (ALM)
Clogged Filters	CF	W	0-9999 sec (60)	Enable, Disab (Enable)	ALM,WRN,MSG (WRN)
High Room Temp	HRT	W	0-9999 sec (10)	Enable, Disab (Enable)	WRN
Low Room Temp	LRT	W	0-9999 sec (10)	Enable, Disab (Enable)	WRN
High Room Hum	HRH	W	0-9999 sec (10)	Enable, Disab (Enable)	WRN
Low Room Hum	LRH	W	0-9999 sec (10)	Enable, Disab (Enable)	WRN
High Temp Sensor A	HTA	W	0-9999 sec (10)	Enable, Disab (Enable)	WRN
Low Temp Sensor A	LTA	W	0-9999 sec (10)	Enable, Disab (Enable)	WRN
High Hum Sensor A	HHA	W	0-9999 sec (10)	Enable, Disab (Enable)	WRN
Low Hum Sensor A	LHA	W	0-9999 sec (10)	Enable, Disab (Enable)	WRN
Page 4 of 7					
Password	PASSWORD	W	-	-	-
Comp 1 Overload	OL1	W	internal	Enable, Disab (Enable)	ALM,WRN,MSG (ALM)
Comp 2 Overload	OL2	W	internal	Enable, Disab (Enable)	ALM,WRN,MSG (ALM)
Comp 1 High Pressure	HP1	W	internal	Enable, Disab (Enable)	ALM,WRN,MSG (ALM)
Comp 2 High Pressure	HP2	W	internal	Enable, Disab (Enable)	ALM,WRN,MSG (ALM)
Comp 1 Low Pressure	LP1	W	internal	Enable, Disab (Enable)	ALM,WRN,MSG (ALM)
Comp 2 Low Pressure	LP2	W	internal	Enable, Disab (Enable)	ALM,WRN,MSG (ALM)
Comp 1 Pumpdown Fail	PD1	W	internal	Enable, Disab (Enable)	ALM,WRN,MSG (ALM)
Comp 2 Pumpdown Fail	PD2	W	internal	Enable, Disab (Enable)	ALM,WRN,MSG (ALM)
Dig Scroll1 High Temp	HT1	W	internal	Enable, Disab (Enable)	ALM,WRN,MSG (ALM)
Dig Scroll2 High Temp	HT2	W	internal	Enable, Disab (Enable)	ALM,WRN,MSG (ALM)
EI Heat Hi Temp	EHO	W	0-9999 sec (5)	Enable, Disab (Enable)	ALM,WRN,MSG (ALM)
Page 5 of 7					
Password	PASSWORD	W	-	-	-
Working Hrs Exceeded	WHE	W	0-9999 sec (0)	Enable, Disab (Enable)	WRN
Smoke Detected	SMO	W	0-9999 sec (5)	Enable, Disab (Enable)	ALM,WRN,MSG (ALM)
Water Under Floor	WUF	W	0-9999 sec (5)	Enable, Disab (Enable)	ALM,WRN,MSG (ALM)
Cond Pump-high Water	CPH	W	0-9999 sec (5)	Enable, Disab (Enable)	ALM,WRN,MSG (ALM)
Loss Of Flow	LOF	W	0-9999 sec (5)	Enable, Disab (Enable)	ALM,WRN,MSG (ALM)
Stby Glycol Pump On	SGP	W	0-9999 sec (5)	Enable, Disab (Enable)	ALM,WRN,MSG (ALM)
Standby Unit On	STB	W	0-9999 sec (5)	Enable, Disab (Enable)	ALM,WRN,MSG (ALM)
Humidifier Problem	HUP	W	0-9999 sec (5)	Enable, Disab (Enable)	ALM,WRN,MSG (ALM)
No Connection w/Unit1	NOC	W	internal	Enable, Disab (Enable)	WRN
Unit X Disconnected	-	W	internal	Enable, Disab (Enable)	WRN
Loss Of Power	LOP	-	-	Enable, Disab (Enable)	ALM,WRN,MSG (WRN)

SET
ALARMS

Table 30 Set alarms parameters (continued)

Function		Read/ Write	Delay (Default)	ENABLE - DISAB (Default)	Alarm Type (Default)
Large Display	Small Display				
Page 6 of 7					
Password	PASSWORD	W	-	-	-
Customer Input 1	CI1	W	0-9999 sec (5)	Enable, Disab (Enable)	ALM,WRN,MSG (ALM)
Customer Input 2	CI2	W	0-9999 sec (5)	Enable, Disab (Enable)	ALM,WRN,MSG (ALM)
Customer Input 3	CI3	W	0-9999 sec (5)	Enable, Disab (Enable)	ALM,WRN,MSG (ALM)
Customer Input 4	CI4	W	0-9999 sec (5)	Enable, Disab (Enable)	ALM,WRN,MSG (ALM)
Call Service	CS	W	0-9999 sec (5)	Enable, Disab (Enable)	ALM,WRN,MSG (ALM)
High Temperature	HTD	W	0-9999 sec (5)	Enable, Disab (Enable)	ALM,WRN,MSG (ALM)
Loss of Air Blower 1	LB1	W	0-9999 sec (5)	Enable, Disab (Enable)	ALM,WRN,MSG (ALM)
Reheat Lockout	RL	W	0-9999 sec (5)	Enable, Disab (Enable)	ALM,WRN,MSG (ALM)
Humidifier Lockout	HL	W	0-9999 sec (5)	Enable, Disab (Enable)	ALM,WRN,MSG (ALM)
Fc Lockout	FCL	W	0-9999 sec (5)	Enable, Disab (Enable)	ALM,WRN,MSG (ALM)
Compressor(S) Lockout	CL	W	0-9999 sec (5)	Enable, Disab (Enable)	ALM,WRN,MSG (ALM)
Page 7 of 7					
Password	PASSWORD	W	-	-	-
Comp 1 Short Cycle	SC1	W	-	Enable, Disab (Enable)	ALM,WRN,MSG (ALM)
Comp 2 Short Cycle	SC2	W	-	Enable, Disab (Enable)	ALM,WRN,MSG (ALM)

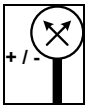
**Table 31 Sensor calibration / setup parameters**

Function		Read/ Write	Range Imperial (metric)	Default Setting
Large Display	Small Display			
Page 1 of 3				
Password	PASSWORD	W	-	-
Return Temperature	RTN TEMP	W	±18°F (±9.9°C)	-
Calibrated Return Temperature	CAL TEMP	R	32-122°F (0-50°C)	-
Return Humidity	RTN HUM	W	±9.9%	-
Calibrated Return Humidity	CAL HUM	R	20-80%	-
Digiscroll 1 NTC	DS1 NTC	W	±18°F (±9.9°C)	-
Calibrated Digiscroll 1 NTC	CAL DS1	R	84-313°F (29,0-156,0°C)	-
Digiscroll 2 NTC	DS2 NTC	W	±18°F (±9.9°C)	-
Calibrated Digiscroll 2 NTC	CAL DS2	R	84-313°F (29,0-156,0°C)	-
Page 2 of 3				
Password	PASSWORD	W	-	-
Temperature Sensor A	TEMP A	W	±18°F (±9.9°C)	-
Calibrated Temperature Sensor A	CAL A	R	32-122°F (0-50,0°C)	-
Humidity Sensor A	HUM A	W	±9.9%	-
Calibrated Humidity Sensor A	CAL A	R	20-80%	-
Temperature Sensor B	TEMP B	W	±18°F (±9.9°C)	-
Calibrated Temperature Sensor B	CAL B	R	32-122°F (0-50,0°C)	-
Humidity Sensor B	HUM B	W	±9.9%	-
Calibrated Humidity Sensor B	CAL B	R	20-80%	-
Page 3 of 3				
Password	PASSWORD	W	-	-
Freecool Sensor PTC or NTC	FC SNSR	W	PTC, NTC	NTC
Freecool Sensor	FC SNSR	W	±18°F (±9.9°C)	-
Calibrated Freecool Sensor	CAL FC	R	4-113°F (-15-45°C)	-
Supply Sensor PTC or NTC	SUP SNSR	W	PTC, NTC	NTC
Supply Sensor	SUP TEMP	W	±18°F (±9.9°C)	-
Calibrated Supply Sensor	CAL SUP	R	32-122°F (0-50,0°C)	-
Temperature Sensor C	TEMP C	W	±18°F (±9.9°C)	-
Calibrated Temperature Sensor C	CAL C	R	32-122°F (0-50,0°C)	-
Humidity Sensor C	HUM C	W	±9.9%	-
Calibrated Humidity Sensor C	CAL C	R	20-80%	-



Table 32 System / network setup parameters—large display only

Function		Read/ Write	Range Imperial (metric)	Default Setting
Large Display	Small Display			
Page 1 of 2				
Password	PASSWORD	W	-	-
Number of Connected Units	—	W	1-32	-
Teamwork Mode	—	W	No,1,2	No
				-
Configuration Safe	—	R	Not Available, Invalid, OK, Changed, Updating	-
Configuration Safe	—	W	No, SaveLoad	No
Network Safe	—	R	Not Available, Invalid, OK, Changed, Updating	-
Network Safe	—	W	No, SaveLoad	No
SW Version	—	W		-
Page 2 of 2				
Password	PASSWORD	W	-	-
IP Address	—	W	IP Range	-
Netmask	—	W	Netmask Range	-
Gateway	—	W	Gateway Range	-
MAC	—	R	MAC Range	-
U2U Protocol	—	W	GBP	-
U2U Address	—	W	33-64	-
U2U Group	—	W	1-99	-
				-
Bootloader Variables	—	R	Not Available, Invalid, OK, Changed, Updating	-
Bootloader Variables	—	W	No, Save+Reboot	No



Table 33 Network setup parameters

Function		Read/ Write	Range Imperial (metric)	Default Setting
Large Display	Small Display			
Page 1 of 2				
Password	PASSWORD	W	-	-
Monitoring Address	MON ADD	W		3
Unit Name	-	W	6 digits	UNIT
Configuration Safe	CS STAT	R	Not Available, Invalid, OK, Changed, Updating	-
Configuration Safe	CS CTRL	W	No, SaveLoad	No
Network Safe	NW STAT	R	Not Available, Invalid, OK, Changed, Updating	-
Network Safe	NW CTRL	W	No, SaveLoad	No
SW Version	SW#	W		-
Page 2 of 2				
Password	PASSWORD	W	-	-
Monitoring Protocol	MON PROT	W	No, Velocity, Hironet, IGM	-
IP Address	IP #1, IP #2, IP #3, IP #4	W	IP Range	-
Netmask	NM #1, NM #2, NM #3, NM #4	W	Netmask Range	-
Gateway	GW #1, GW #2, GW #3, GW #4	W	Gateway Range	-
MAC	MAC	R	MAC Range	-
U2U Protocol	U2U PROT	W	GBP	-
U2U Address	U2U ADD	W	33-64	-
U2U Group	—	W	1-99	-
Bootloader Variables	BL STAT	R	Not Available, Invalid, OK, Changed, Updating	-
Bootloader Variables	BL CTRL	W	No, Save+Reboot	No
Static RAM	SR STAT	R	Not Available, Invalid, OK, Changed, Updating	-
Static RAM	SR CTRL	W	No, Clear+Reboot	No



Table 34 Options setup parameters

Function		Read/ Write	Range Imperial (metric)	Default Setting
Large Display	Small Display			
Page 1 of 2				
Password	PASSWORD	W	-	-
Compressor Sequence	COMP SEQ	R	1, 2, auto	Auto
Low Pressure Alarm Delay	LP DELAY	W	0-5 min	3
Actual LP1 Pressure	LP1 ACT	R	-145.0 - 725.0 psi (-10.0 - 50.0 bar)	-
Actual LP2 Pressure	LP2 ACT	R	-145.0 - 725.0 psi (-10.0 - 50.0 bar)	-
Electric Stages	EL HEAT	W	0, 1, 2, 3	0
Hot Water Heat On/Off	HW HEAT	W	No, Yes	No
Total Heat Stages	ALL HEAT	R	0, 1, 2, 3	-
LWD Connected	LWDconn	W	No, Yes	No
3P Actuator Runtime	3P RUN	W	30-500 sec	165 sec
3P Actuator Direction	3P DIR	W	Direct, Reverse	Direct
Page 2 of 2				
Password	PASSWORD	W	-	-
Humidification Enabled	HUM ENAB	W	No, Yes	Yes
Infrared Flush Rate	IR FLUSH	W	110-500%	150%
Dehumidification Enabled	DEHUM EN	W	No, Yes	Yes
Humidifier Bottle Flush Time	HumFlush	W	5-30 sec	5
Humidifier Bottle Manual Flush	ManFlush	W	Yes, No	No
Single Unit Auto Restart	RESTART	W	0-999 sec	5
On-Off Enabled	ONOFF EN	W	Yes, No	Yes
CW Flush	CW FLUSH	W	0-99 hours	0
Freecooling Flush	FC FLUSH	W	0-99 hours	0
Hot Water Flush	HW FLUSH	W	0-99 hours	0



Table 35 Service contacts parameters

Function		Read/ Write	Range Imperial (metric)	Default Setting
Large Display	Small Display			
Page 1 of 1				
Password	PASSWORD	W	-	-
Country	Country	W	None, United States	USA
Address line 1	Address line 1	W	text-string	-
Address line 2	Address line 2	W	text-string	-
Address line 3	Address line 3	W	text-string	-
Address line 4	Address line 4	W	text-string	-

Notes

Ensuring The High Availability Of Mission-Critical Data And Applications.

Emerson Network Power, the global leader in enabling business-critical continuity, ensures network resiliency and adaptability through a family of technologies—including Liebert power and cooling technologies—that protect and support business-critical systems. Liebert solutions employ an adaptive architecture that responds to changes in criticality, density and capacity. Enterprises benefit from greater IT system availability, operational flexibility and reduced capital equipment and operating costs.

Technical Support / Service Web Site

www.liebert.com

Monitoring

800-222-5877

monitoring@emersonnetworkpower.com

Outside the US: 614-841-6755

Single-Phase UPS

800-222-5877

upstech@emersonnetworkpower.com

Outside the US: 614-841-6755

Three-Phase UPS

800-543-2378

powertech@emersonnetworkpower.com

Environmental Systems

800-543-2778

Outside the United States

614-888-0246

Locations

United States

1050 Dearborn Drive

P.O. Box 29186

Columbus, OH 43229

Europe

Via Leonardo Da Vinci 8

Zona Industriale Tognana

35028 Piove Di Sacco (PD) Italy

+39 049 9719 111

Fax: +39 049 5841 257

Asia

7/F, Dah Sing Financial Centre

108 Gloucester Road, Wanchai

Hong Kong

852 2572220

Fax: 852 28029250

While every precaution has been taken to ensure the accuracy and completeness of this literature, Liebert Corporation assumes no responsibility and disclaims all liability for damages resulting from use of this information or for any errors or omissions.

© 2007 Liebert Corporation

All rights reserved throughout the world. Specifications subject to change without notice.

® Liebert and the Liebert logo are registered trademarks of Liebert Corporation. All names referred to are trademarks or registered trademarks of their respective owners.

SL-18835_REV01_09-07

Emerson Network Power.

The global leader in enabling *Business-Critical Continuity*.

■ AC Power

■ Embedded Computing

■ Outside Plant

■ Racks & Integrated Cabinets

■ Connectivity

■ Embedded Power

■ Power Switching & Controls

■ Services

■ DC Power

■ Monitoring

■ Precision Cooling

■ Surge Protection

Business-Critical Continuity, Emerson Network Power and the Emerson Network Power logo are trademarks and service marks of Emerson Electric Co.

©2007 Emerson Electric Co.